

Z109REG2-1

Universal converter module
with galvanic insulation

Chapter index	Page
1. Preliminary warnings	2
2. Description and characteristics	2
2.1 Module description	
2.2 General characteristics and features	
3. Technical specifications	2
3.1 Input	
3.2 Outputs	
3.3 Connections	
3.4 Power supply	
3.5 Module case	
3.6 Environmental conditions	
4. Preliminary instructions for use	4
5. Electrical connections	4
5.1 Safety measures before use	
5.2 USB interface	
5.3 Connections	
5.4 Power supply	
5.5 Universal input	
5.6 Analog and relay output / strobe input	
6. Configuration	5
6.1 Input selection / Measuring scale	
6.2 START and END setting at will	
6.3 Output selection	
6.4 Configuration through a PC	
6.5 Jumpers position	
6.6 LED indications on the frontal panel	
7. Purchase order code	8
8. Module layout	8
9. Decommissioning and disposal	8

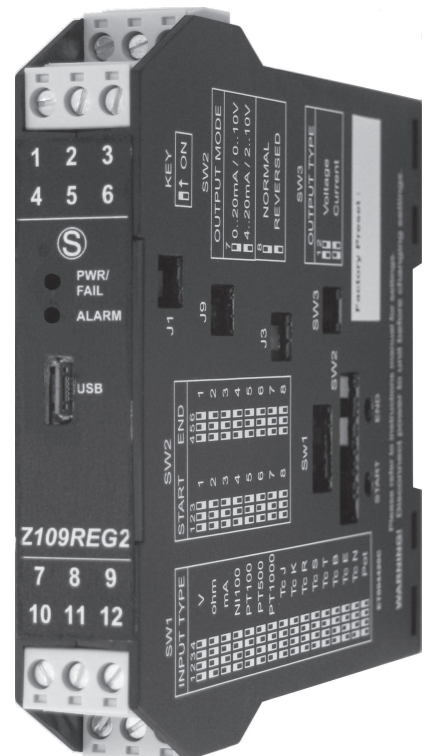

SENECA s.r.l.

Via Austria, 26 – 35127 – PADOVA – ITALY

Tel. +39.049.8705355 – 8705359 Fax. +39.049.8706287

Internet site: www.seneca.it Technical assistance: support@seneca.it

Commercial reference: sales@seneca.it

This document is property of SENECA srl. Duplication and reproduction of it are forbidden (though partial), if not authorized. Contents of present documentation refers to products and technologies described in it. Though we strive for reach perfection continually, all technical data contained in this document may be modified or added due to technical and commercial needs. It's impossible eliminate mismatches and discordances completely. Contents of present documentation is anyhow subjected to periodical revision. If you have any questions don't hesitate to contact our structure or to write us to e-mail addresses as above mentioned.

1. PRELIMINARY WARNINGS

Before carrying out any operation it's mandatory to read all the content of this user Manual. Only electrical-skilled technicians can use the module described in this user Manual. Only the Manufacturer is authorized to repair the module or to replace damaged components. No warranty is guaranteed in connection with faults resulting from improper use, from modifications or repairs carried out by Manufacturer-unauthorised personnel on the module, or if the content of this user Manual is not followed.

2. DESCRIPTION AND CHARACTERISTICS

2.1 MODULE DESCRIPTION

The Z109REG2 module acquires an universal input signal, converts it to an analog format and send it to an universal isolated output.

2.2 GENERAL CHARACTERISTICS AND FEATURES

- Universal input: voltage, current, thermocouples, thermoresistances, potentiometer, rheostat.
- Sensor powered by 2-wire technique: 20 V $\overline{\text{DC}}$ stabilised, 20mA max, short-circuit protected.
- Measurement and re-transmission on isolated analog output, with voltage and current output.
- DIP-switch for selecting: type of input, START-END, output mode (zero elevation, scale inversion), output type (mA or V).
- Front panel indicating: power on, off scale or setting error and alarm status.
- Relay (spst) output, programmable through a PC.
- STROBE input to activate the analog output on PLC command (alternatively to alarm contact).
- Facility for programming the following with a PC: beginning and end scale, additional input types, square root extraction, filter, burn-out etc.
- 3-points insulation: 1500 V \sim .

3. TECHNICAL SPECIFICATIONS

3.1 INPUT

Voltage input:	Bipolar from 75 mV up to 20 V in 9 scales, input impedance 1 M Ω , resolution max 15 bit + sign.
Current input:	Bipolar up to 20 mA, input impedance \sim 50 Ω , resolution: 1 μ A.
thermoresistance (RTD) input: PT100, PT500, PT1000, NI100, KTY81, KTY84-130/-150, NTC.	2, 3 or 4 wires measurement, energising current 0.56 mA, resolution 0.1 $^{\circ}$ C, automatic detection of interruption or RTD. Resistive value for NTC < 25 k Ω . KTY81, KTY84 and NTC may be set only via software
Thermocouple input:	Type J,K,R,S,T,B,E,N; resolution: 2.5 μ V, automatic detection of TC interruption, input impedance >5 M Ω
Rheostat input:	Full scale min 500 Ω , max 25 k Ω .
Potentiometer input:	Excitation voltage 300 mV, input impedance > 5 M Ω , potentiometer value from 500 Ω to 100 k Ω (with the aid of a parallel resistance equal to 500 Ω).
Sampling frequency:	Variable from 240 sps with 11 bits resolution + sign to 15 sps with 15 bits + sign resolution (typical values).
Response time:	35 ms with 11 bits resolution, 140 ms with 16 bits resolution (measurement of voltage, current, potentiometer).

3.2 OUTPUTS

Output:	I: 0-20 / 4-20 mA, max load resistance 600 Ω V: 0-5 V / 0-10 V / 1-5 V / 2-10 V, min load resistance 2 k Ω Resolution: 2.5 μ A / 1.25 mV.
Relay output (spst):	Capacity : 1 A – 30 V $\overline{\text{DC}}$ / V \sim
Data memory:	EEPROM for all configuration data; storage time: 40 years.

INSULATIONS 1500V~	STANDARDS	
	 	<p>The module complies with the following standards: EN61000-6-4 (electromagnetic emission, in industrial environment) EN61000-6-2 (electromagnetic immunity, in industrial environment) EN61010-1 (safety)</p> <p>Notes:</p> <ul style="list-style-type: none"> - Use with copper conductor. - Use in Pollution Degree 2 Environment - Power Supply must be Class 2 - When supplied by an Isolated Limited Voltage and/or Limited Current power supply, a fuse rated max 2.5 A shall be installed in the field.
<p>1500 V~ insulating voltage is among:</p> <ul style="list-style-type: none"> - power supply - analog input - analog output / digital input/ output 		

Errors referred to maximum measuring range:	Calibration Error	Thermal Coefficient	Linearity Error	EMI
Voltage or current input	0.1%	0.01%/°K	0.05%	<1%
TC Input: J, K, E, T, N	0.1%	0.01%/°K	0.2°C	<1% (1)
TC Input: R, S	0.1%	0.01%/°K	0.5°C	<1% (1)
TC Input: B (2)	0.1%	0.01%/°K	1.5°C	<1% (1)
Cold junction compensation (to TC Input)	2°C in ambient range from 0 to 50°C.			
Potentiometer / Resistor Input	0.1%	0.01%/°K	0.1%	<1%
Thermoresistance RTD Input: PT100, PT500, PT1000, NI100 (3)	0.1%	0.01%/°K	0.02% (se t > 0°C) 0.05% (se t < 0°C)	<1% (4)
Voltage output (5)	0.3%	0.01%/°K	0.01%	

- (1) Influence of cable resistance 0.1 μV/Ω.
(2) Output zero if t < 250 °C.
(3) All the values have to be calculated on the resistive value..
(4) Influence of cable resistance 0.005%/Ω max 20 Ω.
(5) Values to be added to the errors of the selected input.

3.3 CONNECTIONS	
USB Interface	Micro USB connector (frontal panel)
3.4 POWER SUPPLY	
Supply Voltage	10-40 V $\overline{=}$, 19-28 V~ 50-60 Hz, through screw terminals: 2 – 3
Power supply unit	Classe 2
Power consumption	1.6 W @ 24 V $\overline{=}$ with output 20 mA; Max: 2.5 W
3.5 MODULE CASE	
Case	PA6, black color
Dimensions	Width L=100mm; Height H=112mm; Depth W=17,5mm
Board terminals	Removable 3 way screw terminals: pitch 5.08mm, section 2.5mm ²
Protection class	IP20
3.6 ENVIRONMENTAL CONDITIONS	
Operating Temperature	-10°C – +60°C (UL: -10°C – +60°C)

3.6 ENVIRONMENTAL CONDITIONS

Humidity	30 – 90 % a 40°C not condensing
Pollution degree	2 (Maximum environment pollution during operations)
Storage Temperature	-20°C – +85°C

4. PRELIMINARY INSTRUCTIONS FOR USE

The module was designed to be installed on omega IEC EN 60715 rail in vertical position.

We suggest the module installation in the lower part of the control panel.

In order to ensure best performance and longest working life module, please ensure adequate ventilation to the modules and avoid placing raceways or other objects which obstructs the ventilation slots.

It's forbidden to install the module near or above heat sources.

«**Severe operating conditions**» are as follows:

- High power supply voltage: $>30\text{ V} \overline{\text{=}}$, $26\text{ V} \sim$.
- The module supplies power to the sensor at input.
- Output used as current generator (connected to a passive module).

If the modules are installed side by side, **separate them by at least 5 mm** in the following cases:

- If the panel operating temperature exceeds 45°C and at least one of the severe operating conditions exists;
- If the panel operating temperature exceeds 35°C and at least two of the severe operating conditions exist.

5. ELECTRICAL CONNECTIONS

5.1 SAFETY MEASURES BEFORE USE

To satisfy the electromagnetic compliance requirements:

- Use shielded cables for signals transmission;
- The cable shield must be connected to an earth wire used specifically for instrumentation;
- Avoid placing signal cables near power cables and power appliances (inverters, motors, induction ovens etc...).

5.2 USB INTERFACE

The module has a microUSB connector, you can configure it through APP and/or software.

For more information please see www.seneca.it/products/z109reg2.

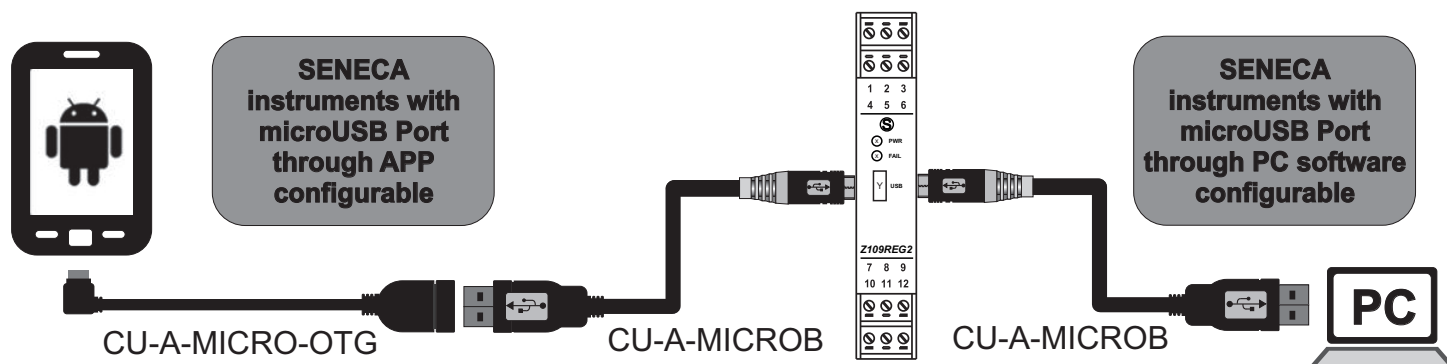

5.3 CONNECTIONS



Please provide the module with supply voltage $< 40\text{ V} \overline{\text{=}}$ or $< 28\text{ V} \sim$.
These upper limits must not be exceeded to avoid serious damage to the module.

5.4 POWER SUPPLY

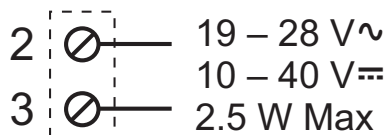

5.5 UNIVERSAL INPUT

CURRENT INPUT

Passive module

The sensor power the loop (mA)

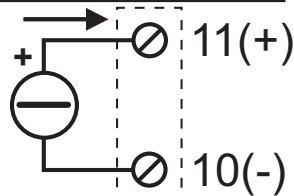

mA input

Active module

The module power the loop (mA)

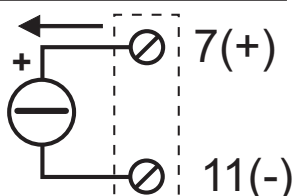

mA input (2 wires)

VOLTAGE INPUT

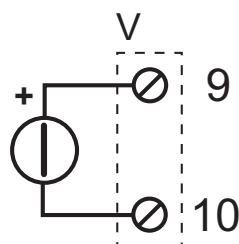

V input > 150 mV

VOLTAGE / THERMOCOUPLE INPUT

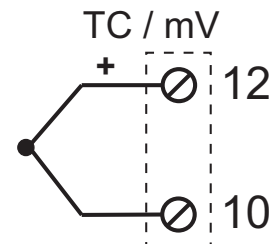

TC input / V input < 150mV

THERMORESISTANCE INPUT

RTD 2 wires

RTD 3 wires

RTD 4 wires

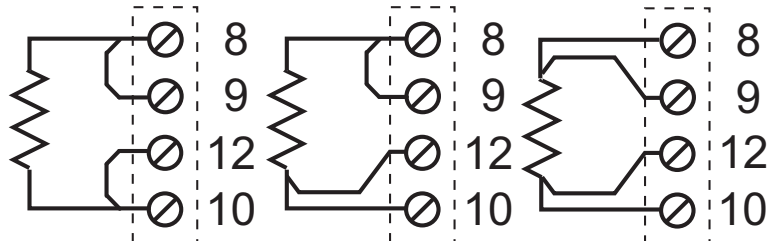

POTENTIOMETER / RHEOSTAT INPUT

POTENTIOMETER

RHEOSTAT

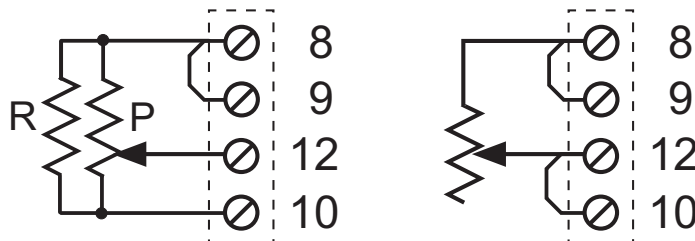

R=500 Ω (not provided),
P= 500 Ω ÷ 100 k Ω

5.6 ANALOG AND RELAY OUTPUT / STROBE INPUT

RE-TRANSMITTED OUTPUT

Voltage

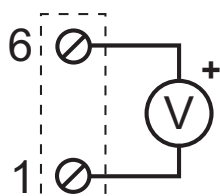

V output

Generated current (6)

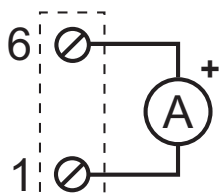

mA output

External power Supply current (7)

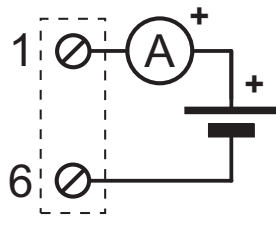

mA output

RELAY OUTPUT(8)

1 A - 30 V



STROBE INPUT (9)

12 - 24 V $\overline{\text{=}}$

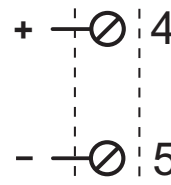

- (6) Powered active output to be connected to passive inputs.
- (7) Unpowered passive output to be connected to active inputs.
In order to select this feature please see: **SETTINGS THROUGH INTERNAL JUMPERS.**
- (8) As an alternative to STROBE input. RELAY output contact normally closed, opened in event of alarm.
- (9) As an alternative to the relay output. It is optoisolated and enables the current analog output.
You can use it to multiplex a PLC input on n Z109REG2.
In order to enable this input please see: **SETTINGS THROUGH INTERNAL JUMPERS.**

6. CONFIGURATION

6.1 INPUT SELECTION / MEASURING SCALE

You can select the type of input by setting SW1 DIP switches placed on the side of the module. Every type of input is matched to a certain number of beginning and end scale values which can be selected through SW2 DIP switches. The following table lists possible START and END values according to the type of input selected. The left column show the DIP-switches setting in order to select the START and END scale desired.



Note: DIP-switches must be set while the module is powered down, otherwise, the module may be damaged.

(*) START and END set in the memory by a PC or by the programming push-buttons.



SW2 DIP-switch in OFF ↓ position

SCALE n°		Voltage		Resistance / Rheostat		Current		Potentiometer	
		START	END	START	END	START	END	START	END
	1	(*)	(*)	(*)	(*)	(*)	(*)	(*)	(*)
	2	0 V	100 mV	0 Ω	1 kΩ	0 mA	1 mA	0 %	40 %
	3	400 mV	200 mV	0.5 kΩ	2 kΩ	1 mA	2 mA	10 %	50 %
	4	1 V	500 mV	1 kΩ	3 kΩ	4 mA	3 mA	20 %	60 %
	5	2 V	1 V	2 kΩ	5 kΩ	-1 mA	4 mA	30 %	70 %
	6	-5 V	5 V	5 kΩ	10 kΩ	-5 mA	5 mA	40 %	80 %
	7	-10 V	10 V	10 kΩ	15 kΩ	-10 mA	10 mA	50 %	90 %
	8	-20 V	20 V	15 kΩ	25 kΩ	-20 mA	20 mA	60 %	100 %
SCALE n°		NI100 (RTD)		PT100 (RTD)		PT500 (RTD)		PT1000 (RTD)	
		START	END	START	END	START	END	START	END
	1	(*)	(*)	(*)	(*)	(*)	(*)	(*)	(*)
	2	-50 °C	20 °C	-200 °C	50 °C	-200 °C	0 °C	-200 °C	0 °C
	3	-30 °C	40 °C	-100 °C	100 °C	-100 °C	50 °C	-100 °C	50 °C
	4	-20 °C	50 °C	-50 °C	200 °C	-50 °C	100 °C	-50 °C	100 °C
	5	0 °C	80 °C	0 °C	300 °C	0 °C	150 °C	0 °C	150 °C
	6	20 °C	100 °C	50 °C	400 °C	50 °C	200 °C	50 °C	200 °C
	7	30 °C	150 °C	100 °C	500 °C	100 °C	300 °C	100 °C	300 °C
	8	50 °C	200 °C	200 °C	600 °C	150 °C	400 °C	200 °C	400 °C
SCALE n°		Thermocouple J		Thermocouple K		Thermocouple R		Thermocouple S	
		START	END	START	END	START	END	START	END
	1	(*)	(*)	(*)	(*)	(*)	(*)	(*)	(*)
	2	-200 °C	100 °C	-200 °C	200 °C	0 °C	400 °C	0 °C	400 °C
	3	-100 °C	200 °C	-100 °C	400 °C	100 °C	600 °C	100 °C	600 °C
	4	0 °C	300 °C	0 °C	600 °C	200 °C	800 °C	200 °C	800 °C
	5	100 °C	400 °C	100 °C	800 °C	300 °C	1000 °C	300 °C	1000 °C
	6	200 °C	500 °C	200 °C	1000 °C	400 °C	1200 °C	400 °C	1200 °C
	7	300 °C	800 °C	300 °C	1200 °C	600 °C	1400 °C	600 °C	1400 °C
	8	500 °C	1000 °C	500 °C	1300 °C	800 °C	1750 °C	800 °C	1750 °C
SCALE n°		Thermocouple T		Thermocouple B (#)		Thermocouple E		Thermocouple N	
		START	END	START	END	START	END	START	END
	1	(*)	(*)	(*)	(*)	(*)	(*)	(*)	(*)
	2	-200 °C	50 °C	0 °C	500 °C	-200 °C	50 °C	-200 °C	200 °C
	3	-100 °C	100 °C	500 °C	600 °C	-100 °C	100 °C	-100 °C	400 °C
	4	-50 °C	150 °C	600 °C	800 °C	0 °C	200 °C	0 °C	600 °C
	5	0 °C	200 °C	700 °C	1000 °C	100 °C	300 °C	100 °C	800 °C
	6	50 °C	250 °C	800 °C	1200 °C	150 °C	400 °C	200 °C	1000 °C
	7	100 °C	300 °C	1000 °C	1500 °C	200 °C	600 °C	300 °C	1200 °C
	8	150 °C	400 °C	1200 °C	1800 °C	400 °C	800 °C	500 °C	1300 °C

LEGENDA **ON** **OFF**

(#) Output = 0 (zero) when t < 250°C.

SW1: INPUT SELECTION									
POSITION				INPUT					
1	2	3	4	TYPE	1	2	3	4	TYPE
<input type="checkbox"/>	<input type="checkbox"/>	<input type="checkbox"/>	<input type="checkbox"/>	V	<input type="checkbox"/>	<input type="checkbox"/>	<input type="checkbox"/>	<input type="checkbox"/>	Tc K
<input type="checkbox"/>	<input type="checkbox"/>	<input type="checkbox"/>	<input type="checkbox"/>	Ω / Rheostat	<input type="checkbox"/>	<input type="checkbox"/>	<input type="checkbox"/>	<input type="checkbox"/>	Tc R
<input type="checkbox"/>	<input type="checkbox"/>	<input type="checkbox"/>	<input type="checkbox"/>	mA	<input type="checkbox"/>	<input type="checkbox"/>	<input type="checkbox"/>	<input type="checkbox"/>	Tc S
<input type="checkbox"/>	<input type="checkbox"/>	<input type="checkbox"/>	<input type="checkbox"/>	NI100	<input type="checkbox"/>	<input type="checkbox"/>	<input type="checkbox"/>	<input type="checkbox"/>	Tc T
<input type="checkbox"/>	<input type="checkbox"/>	<input type="checkbox"/>	<input type="checkbox"/>	PT100	<input type="checkbox"/>	<input type="checkbox"/>	<input type="checkbox"/>	<input type="checkbox"/>	Tc B
<input type="checkbox"/>	<input type="checkbox"/>	<input type="checkbox"/>	<input type="checkbox"/>	PT500	<input type="checkbox"/>	<input type="checkbox"/>	<input type="checkbox"/>	<input type="checkbox"/>	Tc E
<input type="checkbox"/>	<input type="checkbox"/>	<input type="checkbox"/>	<input type="checkbox"/>	PT1000	<input type="checkbox"/>	<input type="checkbox"/>	<input type="checkbox"/>	<input type="checkbox"/>	Tc N
<input type="checkbox"/>	<input type="checkbox"/>	<input type="checkbox"/>	<input type="checkbox"/>	Tc J	<input type="checkbox"/>	<input type="checkbox"/>	<input type="checkbox"/>	<input type="checkbox"/>	Potentiometer

SW2: START e END							
POSITION			START	POSITION			END
1	2	3	SCALE n°	4	5	6	SCALE n°
<input type="checkbox"/>	<input type="checkbox"/>	<input type="checkbox"/>	1	<input type="checkbox"/>	<input type="checkbox"/>	<input type="checkbox"/>	1
<input type="checkbox"/>	<input type="checkbox"/>	<input type="checkbox"/>	2	<input type="checkbox"/>	<input type="checkbox"/>	<input type="checkbox"/>	2
<input type="checkbox"/>	<input type="checkbox"/>	<input type="checkbox"/>	3	<input type="checkbox"/>	<input type="checkbox"/>	<input type="checkbox"/>	3
<input type="checkbox"/>	<input type="checkbox"/>	<input type="checkbox"/>	4	<input type="checkbox"/>	<input type="checkbox"/>	<input type="checkbox"/>	4
<input type="checkbox"/>	<input type="checkbox"/>	<input type="checkbox"/>	5	<input type="checkbox"/>	<input type="checkbox"/>	<input type="checkbox"/>	5
<input type="checkbox"/>	<input type="checkbox"/>	<input type="checkbox"/>	6	<input type="checkbox"/>	<input type="checkbox"/>	<input type="checkbox"/>	6
<input type="checkbox"/>	<input type="checkbox"/>	<input type="checkbox"/>	7	<input type="checkbox"/>	<input type="checkbox"/>	<input type="checkbox"/>	7
<input type="checkbox"/>	<input type="checkbox"/>	<input type="checkbox"/>	8	<input type="checkbox"/>	<input type="checkbox"/>	<input type="checkbox"/>	8

6.2 START AND END SETTING AT WILL

The START and END push-buttons under the SW2 DIP-switch group allow to set the beginning and end scale at will, within the scale pre-set through the dip-switches. To obtain this facility it is necessary to use a suitable signal generator, able to furnish the desired values of beginning and end scale.

The procedure is following:

1. Set through dip-switches the type of input, START and END measurement which include the required beginning and end values.
2. Power up the module.
3. Supply a calibrator or simulator of the signal you wish to measure and re-transmit.
4. Set the required START value on the calibrator (or other instrument).
5. Press the START push-button for at least 3 sec. The green LED on the front panel flashes to indicate the value has been stored.
6. Repeat points 4 and 5 for the required END value.
7. Power off the module and set to OFF position the dip-switches of group SW2, correspondent to the settings of START and END values.

The module is now configured for the required start and end scale.

In order to re-program it (e.g. for a different type of input) repeat the whole procedure.

6.3 OUTPUT SELECTION

SW2 group DIP-switches 7 and 8 enable you to set the output with or without zero elevation and/or as a normal or reversed output. The SW3 DIP-switch group enables you to select the output type.

Note:The DIP-switches must be set while the module is powered down, avoiding electrostatic discharge, otherwise the module may be damaged.

SW2: SCALE AND MODE OUTPUT					
POSITION		OUTPUT	POSITION		OUTPUT
7	8	RANGE	7	8	MODE
<input type="checkbox"/>	X	0..20mA / 0..10V	X	<input type="checkbox"/>	NORMAL
<input type="checkbox"/>	X	4..20mA / 2..10V	X	<input type="checkbox"/>	REVERSE

SW3: OUTPUT TYPE					
POSITION		OUTPUT	POSITION		OUTPUT
1	2	TYPE	1	2	TYPE
<input type="checkbox"/>	<input type="checkbox"/>	VOLTAGE	<input type="checkbox"/>	<input type="checkbox"/>	CURRENT
LEGENDA		<input type="checkbox"/> ↑ ON	<input type="checkbox"/> ↓ OFF		

6.4 CONFIGURATION THROUGH A PC

By using a PC and EASY SETUP software, it is possible to set other normally fixed parameters in addition to start and end scale:

Additional input types: digital filter (normally disabled), square root extraction (normally disabled), negative burn-out (normally positive), alarm (normally set as error signalling, start and end scale of the analog output, value of the analog output in case of error, rejection programmable for 50 or 60 Hz mains frequency (normally set to 50 Hz), sampling frequency/resolution (normally set to 15 sps/16 bit), 3 or 4 wires measure for thermal resistance (normally set to 3 wires) and action of the digital output alarm in case of fault.

Instructions for setting and the connection cable are supplied with the software (this must be requested as an accessory item).

6.5 JUMPERS POSITION

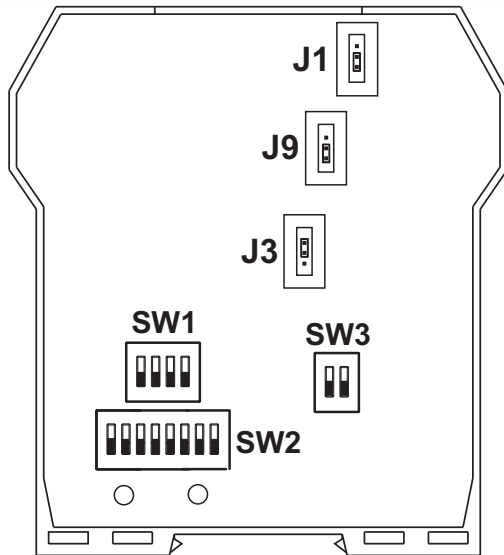

SETTINGS THROUGH INTERNAL JUMPERS

ACTIVE / PASSIVE OUTPUT

Active Output



Passive Output



RELAY OUTPUT / STROBE INPUT

Relay Output



STROBE Input



6.6 LED INDICATIONS ON THE FRONTAL PANEL

LED	LED STATE	LED MEANING
PWR Green	ON	Power supply presence
	Blinking (freq: 1 flash./sec)	Out of Scale, Burn Out or Internal failure
	Blinking (freq ≈ 2 flash./sec)	DIP-switches setting error
FAIL Yellow	ON	Alarm event (open relay contact)
	OFF	No Alarm (closed relay contact)

7. PURCHASE ORDER CODE

ORDER CODE	SPECIFICATIONS
CU-A-MICROB	USB-microUSB 1 mt communication cable.
CU-A-MICRO-OTG	Adapter cable for smartphone.

8. MODULE LAYOUT

FRONTAL PANEL	MODULE DIMENSIONS

9. DECOMMISSIONING AND DISPOSAL



Disposal of Electrical & Electronic Equipment (Applicable throughout the European Union and other European countries with separate collections programs). This symbol, found on your product or on its packaging, indicates that this product should not be treated as household waste when you wish to dispose of it. Instead, it should be handed over to an applicable collection point for the recycling of electrical & electronic equipment. By ensuring this product is disposed of correctly, you will help prevent potential negative consequences to the environment and human health, which could otherwise be caused by inappropriate disposal of this product. The recycling of materials will help to conserve natural resources. For more detailed information about the recycling of the product, please contact your local city office, waste disposal service of the retail store where you purchased this product.