

Input: 0-25 Hz to 0-20 kHz
Output: Two 8 Amp SPDT Relays

- *Factory Set Input Range*
- *Removable Plugs for Faster Installation*
- *Input LoopTracker® and Alarm Status LEDs*
- *Full 1200 V Isolation*
- *Alarm Test, Optional Reset Button*

Applications

- *Machinery Speed Alarm*
- *Redundant or Backup Alarm*
- *Conveyor or Machine Malfunction Alarm*

Frequency Input Range

Factory configured, please specify input type and range
 Frequency: 0-25 Hz to 0-20 kHz
 Sine wave, sawtooth, or square wave with min. 5 usec pulse

Input Impedance

At maximum sensitivity: 10 kΩ nominal
 At minimum sensitivity: 100 kΩ nominal

Input Sensitivity/Hysteresis

Multi-turn potentiometer for sensitivity adjustment
 Maximum sensitivity: ±25 mV typical
 Minimum sensitivity: ±2.5 V typical

Input Amplitude Range

100 mV to 150 VRMS
 Any waveform with minimum 100 mV amplitude change

Input Power Supply

15 VDC ±10%, regulated, 25 mA DC, max. ripple, <10 mVRMS
 May be used to power sensor

Input Protection

Normal mode: 200% of input rating
 Common mode: 600 VDC or 600 VAC_p input to ground

LoopTracker

Variable brightness LED indicates input loop level and status

APD 1700 Relay Output

Single setpoint dual SPDT Form C contact sets
 Standard: HI alarm, non-latching, normal acting
 Options: LO alarm, latching, reverse acting

APD 1720 Relay Output

2 independent setpoint SPDT Form C contact sets
 Standard: HI/LO alarm, non-latching, normal acting
 Options: LO/LO, HI/LO, LO/LO alarms, latching, reverse acting

APD 1730 Relay Output

2 independent setpoint SPDT Form C contact sets
 Standard: Band alarm (both alarms trip if outside LO and HI trip points), non-latching, normal acting
 Options: Inverse band alarm, latching, reverse acting

Relay Contact Ratings

8 A max @ 240 VAC resistive load
 External contact protection such as an RC snubber is recommended for inductive loads

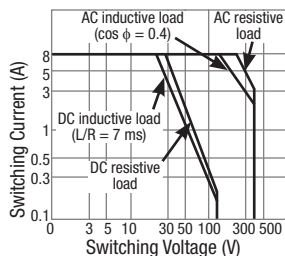

Setpoint

12 turn potentiometer adjustable from 0 to 100% of span

Deadband

12 turn potentiometer adjustable from 1 to 100% of span

Response Time

70 milliseconds typical

Output Test/Reset Button

Front button or external contact closure toggles relays to opposite state when pressed.
 Resets relay if latching relay option is ordered.

APD 1730 discontinued

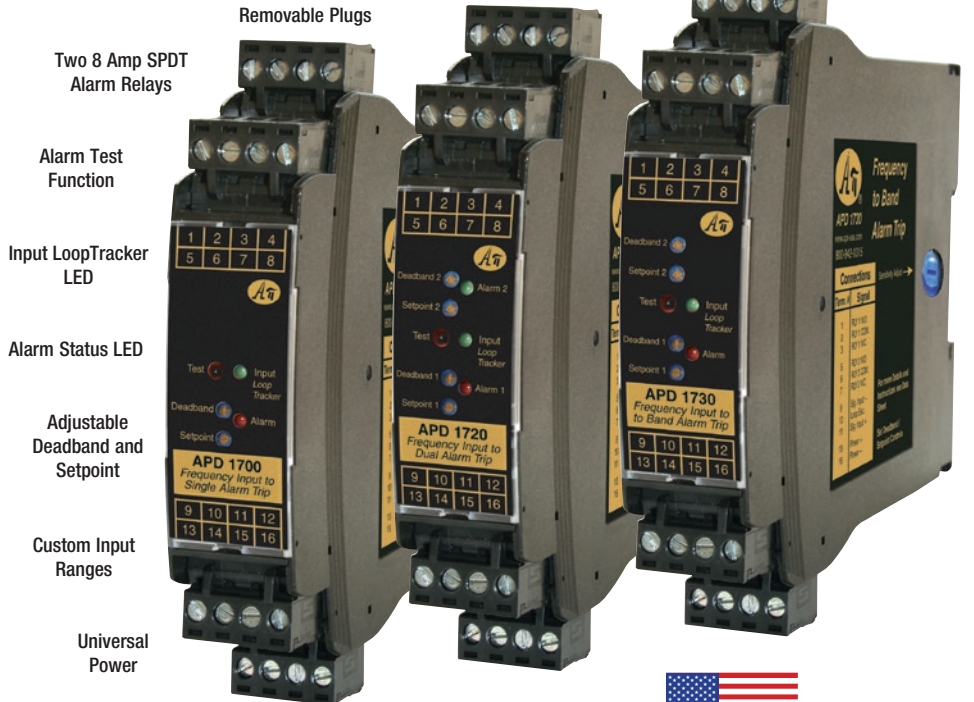

File E145968
 85-265 VAC, 60-300 VDC
 model only



Free Factory I/O Setup!

Quick Link
api-usa.com/1700

Dimensions

0.89" W x 4.62" H x 4.81" D
 (22.5 x 117 x 122 mm)
 Height includes connectors

Ambient Temperature Range and Stability

-10°C to +60°C operating ambient
 Better than 1% of span over operating temperature range
 Better than 0.04% of span per °C

Housing and Connectors

IP 40, requires installation in panel or enclosure
 For use in Pollution Degree 2 Environment
 Mount vertically to a 35 mm DIN rail
 Four 4-terminal removable connectors, 14 AWG max wire size

Power

85-265 VAC, 50/60 Hz or 60-300 VDC, 2 W maximum
 D versions: 9-30 VDC or 10-32 VAC 50/60 Hz, 2 W maximum

Model	Input	Standard Alarm Configuration	Power
APD 1700	Factory ranged specify frequency range 0-25 Hz to 0-20 kHz	Single setpoint dual SPDT relays	85-265 VAC or 60-300 VDC
APD 1700 D		HI alarm, non-latching, normal acting	9-30 VDC or 10-32 VAC
APD 1720		2 setpoints, 2 SPDT relays	85-265 VAC or 60-300 VDC
APD 1720 D		HI/LO alarms, non-latching, normal acting	9-30 VDC or 10-32 VAC
APD 1730		2 setpoints, 2 SPDT relays	85-265 VAC or 60-300 VDC
APD 1730 D		Band alarm, non-latching, normal acting	9-30 VDC or 10-32 VAC

Alarm Options—add to end of model number

- L** APD 1700 with LO trip. Alarms trip on decreasing signal.
- HH** APD 1720 with HI/LO trip. Alarms trip at their respective trip points on increasing signal.
- LL** APD 1720 with LO/LO trip. Alarms trip at their respective trip points on decreasing signal.
- LH** APD 1720 with LO/LO trip. Alarm 1 trips on decreasing signal. Alarm 2 trips on increasing signal.
- IB** APD 1730 with Inverse Band alarm. Both alarms trip if signal is between LO and HI trip points.

Description

The APD 1700 series accepts a frequency input and provides a visual alarm indication and alarm relay contact outputs.

The input is factory configured to a specific frequency input range. The input can be of any type as long as it has a minimum of 100 mV amplitude change and a minimum 5 microsecond pulse width. Input sensitivity is potentiometer adjustable.

Front-accessible potentiometers are used to adjust each alarm setpoint and deadband.

LoopTracker and Alarm Status LEDs

API exclusive features include a LoopTracker LED that varies in intensity with changes in the process input signal. A red/green bicolor alarm status LED (two on the APD 1720 and 1730) visually indicate alarm status. These LEDs provide a quick visual picture of your process at all times.

Output Test / Unlatch

The API exclusive Output Test button can be used to verify the alarm and system operation and also provides the additional function of unlatching the alarm when the latching option has been ordered. This feature can be remotely operated.

The output test button greatly aids in saving time during initial startup and/or troubleshooting.

- HT** Latching alarm with push button reset
- HP** Latching alarm with power-off reset. Module power must be turned off to reset alarms
- R** Reverse-acting alarms. Relay coils energized in an alarm condition. No alarm condition with module power off.
- U** Conformal coating for moisture resistance

Accessory—order as separate line item

API BP4 Spare removable 4 terminal plug, black

Precautions

WARNING! All wiring must be performed by a qualified electrician or instrumentation engineer. See diagram for terminal designations and wiring examples. Consult factory for assistance.

WARNING! Avoid shock hazards! Turn signal input, output, and power off before connecting or disconnecting wiring, or removing or installing module.

Précautions

ATTENTION! Tout le câblage doit être effectué par un électricien ou ingénieur en instrumentation qualifié. Voir le diagramme pour désignations des bornes et des exemples de câblage. Consulter l'usine pour assistance.

ATTENTION! Éviter les risques de choc! Fermez le signal d'entrée, le signal de sortie et l'alimentation électrique avant de connecter ou de déconnecter le câblage, ou de retirer ou d'installer le module.

Sensor Input

The input range is pre-configured at the factory. The module is compatible with most types of sensors as long as the waveform produces a minimum 100 mV amplitude change and a minimum 5 microsecond pulse width.

Refer to the sensor manufacturer's data sheet to determine proper wiring and supply voltage compatibility. A 15 VDC supply is available to power the sensor if required.

The signal input is capacitively coupled to prevent any DC in the input. Some sensors, typically those without an internal load resistor, require a resistive load in order to function.

The resistor value may be specified by the sensor manufacturer as the "minimum resistive load" or calculated from the sensor manufacturer's specified "load current range".

The 15 VDC power supply is capable of providing 25 mA. A load current range of 3 mA to 25 mA would typically use a 5 kΩ to 500 Ω resistor.

NPN sensors use an external resistor across terminals 9 and 10 if required.

PNP sensors use an external resistor across terminals 9 and 11 if required.

Input Sensitivity Adjustment

A multi-turn potentiometer provides an adjustable threshold level that the incoming signal must overcome before an output can be produced. This is used to limit noise and minimize false input signals that may cause erroneous alarm trips.

When fully clockwise (maximum sensitivity), the input threshold is typically ± 25 mV.

In the fully counterclockwise position (minimum sensitivity), the input threshold is typically ± 2.5 volts.

Alarm Types

Note that the deadband is symmetrical about the setpoint; relay trip and reset points will both change if either the setpoint or deadband are changed.

High Alarm (default, H, or HH): The alarm relay changes state when the input signal exceeds the deadband trip point. The relay resets when the input signal drops below the deadband reset point. For a high alarm, the trip point is above the reset point.

Low Alarm (L or LL): The alarm relay changes state when the input signal goes below the deadband trip point. The relay resets when the input signal exceeds the deadband reset point. For a low alarm the trip point is below the reset point.

Band Alarm: Both alarm relays change state when the input signal is outside either deadband trip point.

Inverse Band Alarm (IB): The alarm relay changes state when the input signal is inside either deadband trip point.

HT: Latching alarm with push button reset

HP: Latching alarm with power-off reset. Module power must be turned off to reset alarms

R: Reverse-acting alarms. Relay coils energized in an alarm condition. No alarm condition with module power off.

Relay Output Terminals

See wiring diagrams below right for connections. APD modules do not provide power to the relay contacts. Inductive loads (motors, solenoids, contactors, etc.) will greatly shorten relay contact life unless an appropriate RC snubber is installed.

The APD 1700 operates two sets of relays in unison with a single setpoint. The dual SPDT contact sets are in a Form C configuration.

The APD 1720 operates two sets of relays independently, each with its own setpoint. The dual SPDT contact sets are in a Form C configuration.

The APD 1730 operates two sets of relays, each with its own setpoint in a band alarm configuration. The dual SPDT contact sets are in a Form C configuration.

Module Power Terminals

Check model/serial number label for module operating voltage to make sure it matches available power.

When using DC power, either polarity is acceptable, but for consistency with similar API products, positive (+) can be wired to terminal 13 and negative (-) can be wired to terminal 16.

Mounting to a DIN Rail

Install module vertically on a 35 mm DIN rail in a protective enclosure away from heat sources. Do not block air flow.

1. Tilt front of module downward and position against DIN rail.
2. Clip lower mount to bottom edge of DIN rail.
3. Push front of module upward until upper mount snaps into place.

Removal

1. Push up on the bottom back of the module.
2. Tilt front of module downward to release upper mount from top edge of DIN rail.
3. The module can now be removed from the DIN rail.

Alarm Setup

Relay operation is factory configured. See the model/serial number label for relay configurations.

The Setpoint potentiometer allows the operator to adjust the level at which the alarm is activated. This control is adjustable from 0 to 100% of the input range.

The Deadband potentiometer allows the alarm trip and reset window to be adjusted symmetrically about the setpoint from 1 to 100% of the span. This allows the operator to fine tune the point at which the alarm trips and resets. The deadband is typically used to prevent chattering of the relays or false trips when the process signal is unstable or changes rapidly.

To calibrate the alarm section, set the deadband control to the minimum (counterclockwise). The deadband will be 1.0% of input span in this case.

Set the signal source to the desired trip point.

Adjust the setpoint control to the point at which the relay changes state from a non-alarm to an alarm condition.

Turn the deadband potentiometer clockwise for a larger amount of deadband. The deadband is symmetrical about the setpoint; both transition points will change as deadband is increased.

Relay set and reset points will both change if the setpoint or deadband are changed. Alternately set the setpoint and deadband until the desired trip and reset points are set.

Output Test Function

When the front test button is depressed it will drive the relays to their opposite state. A customer-supplied switch connected to terminals 4 and 8 can also be used to toggle the relays. When released, the relays will return to their prior states.

This can be used as a diagnostic aid during initial start-up or troubleshooting, or as a manual over-ride function. The Test button also resets the relays on models with the HT option.

Operation

The green LoopTracker® input LED provides a visual indication that a signal is being sensed by the input circuitry of the module. It also indicates the input signal strength by changing in intensity as the process changes from minimum to maximum.

If the LED fails to illuminate, or fails to change in intensity as the process changes, check the module power or signal input wiring. Note that it may be difficult to see the LEDs under bright lighting conditions.

The bicolor alarm LED provides a visual indication of the alarm status. In all configurations, a green LED indicates a non-alarm condition and a red LED indicates an alarm condition.

In the normal mode of operation, the relay coil is energized in a non-alarm condition and de-energized in an alarm condition. This will create an alarm condition if the module loses power. For a normal acting, non-latching configuration, the alarm will activate when the input signal exceeds the setpoint (HI alarm) or falls below the setpoint (LO alarm), then will automatically reset when the alarm condition no longer exists.

For a reverse acting alarm, the relay coil is de-energized in a non-alarm condition and energized in an alarm condition. The alarm activates when the input signal exceeds the setpoint (HI alarm) or falls below the setpoint (LO alarm), then automatically resets when the alarm condition no longer exists.

For models with the latching relay option, it will be necessary to push the Test button or remove power from the module to reset the alarm, depending on the type of latching option. The alarm will only reset if the alarm condition no longer exists.

API maintains a constant effort to upgrade and improve its products. Specifications are subject to change without notice. Consult factory for your specific requirements.

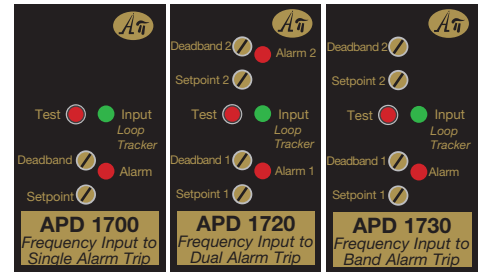
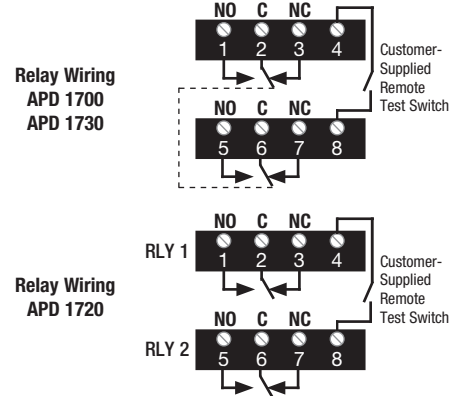

Two wire powered

9 Signal
11 Power (+15 VDC)
Some sensors may require a bleed resistor.

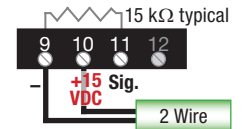

Two wire self-generating

9 Signal (+)
11 Common (-)

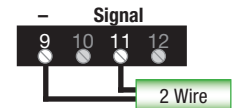

Three wire NPN

9 Signal: Black or White
10 Power (+15VDC): Brown or Red
11 Common (-) Blue or Black
Load resistor may be required.

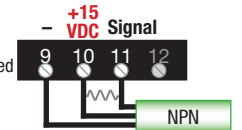

Three wire PNP

9 Signal: Black or White
10 Power (+15VDC): Brown or Red
11 Common (-) Blue or Black
Load resistor may be required.

