

Operating Instructions Multifunctional Power Monitor with System Analysis

SINEAX A 230 / A 230s



Camille Bauer LTD
Aargauerstrasse 7
CH-5610 Wohlen/Switzerland
Phone +41 56 618 21 11
Fax +41 56 618 21 21
info@camillebauer.com
www.camillebauer.com

A 230 / A230s Be 154 807-10 03.13



The instruments must only be disposed of in the correct way!

Safety notes

The installation and commissioning should only be carried out by trained personnel.

Check the following points before commissioning:

- that the maximum values for all the connections are not exceeded, see the “Technical data” section,
- that the connection wires are not damaged, and that they are not live during wiring,
- that the power flow direction, and the phase rotation are correct.

The instrument must be taken out of service if safe operation is no longer possible (e.g. visible damage). In this case, all the connections must be switched off. The instrument must be returned to the factory or to an authorized service dealer.

It is forbidden to open the housing and to make modifications to the instrument. The instrument is not equipped with an integrated circuit breaker. During installation check that a labeled switch is installed and that it can easily be reached by the operators.

Unauthorized repair or alteration of the unit invalidates the warranty.

Contents

	Page
Brief description	2
Technical data	2
Commissioning	3
Electrical connections	3
Measured value display	5
Operation	9
Display window	10
Programming	13
Programming charts	20
Dimensional drawing	22

Brief description

Panel mounting instrument A230 with dimensions 144x144x46mm resp. A230s with dimensions 96 x 96 x 46 mm. Four-quadrant measurement for power system and consumption analysis in single and multi-phase AC systems. Three large LED displays with four digits plus sign. The converter data are included for direct display and further processing. Configurable display settings for user specific presentation, integrated energy meters, impulse counters, and limit value indication. Comprehensive average value and max./min. value functions. Harmonic analysis and THD measurement. Determination of the neutral wire current. Asymmetry factor and neutral point voltage shift. Two switched outputs for the control of impulse counters, or for signalling limit alarms.

Technical data

(for more detailed information please see datasheet, download under www.camillebauer.com)

Measuring inputs \rightarrow

Nominal frequency:	50, 60 Hz
Nominal input voltage:	Phase-phase: 500 V Phase - N: 290 V
Nominal input current:	5 A or 1 A

Continuous thermal rating of inputs

10 A at 346 V in single-phase AC system 10 A at 600 V in three-phase system
--

Short-time thermal rating of inputs

Input variable	Number of inputs	Duration of overloads	Interval between two overloads
577 V LN	10	1 s	10 s
100 A	10	1 s	100 s
100 A	5	3 s	5 min

Measuring ranges

U, I, S:	$\leq 120\%$ of nominal value
P, Q:	$\leq \pm 120\%$ of nominal value
F:	45 to 65 Hz
cos ϕ :	± 1

Display

The measurement display is 4 digit (frequency) and right justified. Energy values are displayed with 8 digits.

Zero value suppression

PF resp cos ϕ :	Display ---, if $S_x < 0.2\% S_{nenn}$
Currents:	Display 0, if $I_x < 0.1\% I_{nenn}$
unb. U:	Display 0, if $\emptyset U < 5\% U_{nenn}$

Pulse/Limit value outputs \rightarrow

Depending on the function selected, the two digital outputs can be used either as pulse outputs for actual and reactive energy or as limit signals.

The outputs are passive, and are galvanically isolated from all the other circuits by opto-couplers. They are suitable to drive tariff devices (S0-standard DIN 43 864), or 24 V relays.

U_{ext}	≤ 40 V DC (OFF: leakage current ≤ 0.1 mA)
I_L	≤ 150 mA (ON: terminal voltage ≤ 1.2 V)

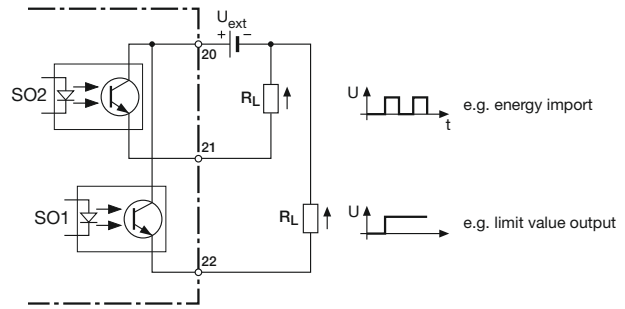

Limit value outputs

The measured values can be freely allocated.

Pulse outputs

Active and reactive energy pulses can be generated for the control of electronic and electromechanical counters.

Power supply \rightarrow

DC-, AC power pack 50 to 400 Hz
100 to 230 V AC/DC $\pm 15\%$ or 24 to 60 V AC/DC $\pm 15\%$
(UL) 85 bis 125 V DC
Power consumption: 3 VA (without extension module)



A marked and easily accessible current limiting switch has to be arranged in the vicinity of the device for turning off the power supply. Fusing should be 10 Amps or less and must be rated for the available voltage and fault current.

Reference conditions

acc. to IEC 688 resp EN 60 688
Sine 50 - 60 Hz, 15 - 30°, application group II

Measurement accuracy (related to nominal value)

Current, voltage	$\pm 0.2\%$
Power	$\pm 0.5\%$
Power factor	$\pm 0.5\%$
Energy	$\pm 0.5\%$
Frequency	± 0.02 Hz (abs.)

Environmental conditions

Operating temperature:	-10 to +55 °C
Storage temperature:	-25 to +70 °C
Humidity relative:	$\leq 75\%$
Altitude:	2000 m max.
Indoor use statement	

Safety

Protection class:	II (voltage inputs with protection impedances)
Measuring category:	III
Pollution degree:	2
Measurement voltage:	300 V
Test voltage:	Between current inputs, power supply, digital outputs, terminals of the plugged-in module: 3700 V / 50 Hz / 1 min. On voltage inputs: 4.25 kV 1.2/50 μ s
Module connections:	The pin rail at the back is connected to the voltage inputs via a protection impedance. Only the permitted modules can be plugged-in!
Enclosure protection:	IP 20

Commissioning

The multifunctional power monitor is made operational by switching on the power supply. The following appears sequentially on the display:

- Segment tests:** all the segments of the displays and all the LEDs are lit for 2 s.
- Version of the software:** e.g. A 230 1.04
- The 3 **line voltages** at switching on.

Loss of the power supply

All the values configured remain during a loss of the power supply. On reconnecting the power supply, the last **mode** selected is displayed.

Note of maintenance

No maintenance is required.

Electrical connections

	Safety Disconnects The mains supply power to the instrument must be installed downstream from a switched current limiting device. The circuit protection device should be 20 Amps or less, and must be rated for the available voltage and fault current; 5 Amp fuses are preferred.
	WARNING All mains supply power to the instrument must be installed downstream from a switched current limiting device. The circuit protection device should be 20 Amps or less, and must be rated for the available voltage and fault current; 5 Amps are preferred.
	The national provisions (e.g. in Germany VDE 0100 "Conditions concerning the erection of heavy current facilities with rated voltages below 1000 V") have to be observed in the installation and material selection of electric lines!
	When using external PT's or CT's refer to the manufacturer's information for connections for voltage and current monitoring.

The electrical connections are identical for the SINEAX A 230 and A 230s.

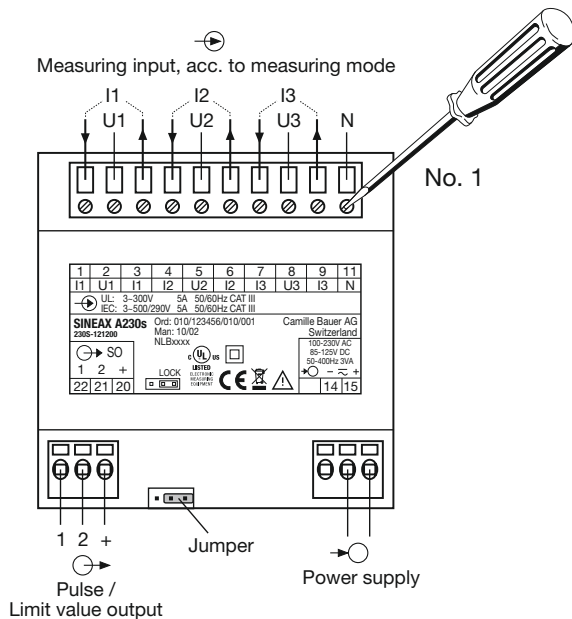

Symbol	Meaning
	Device may only be disposed of in a professional manner!
	Double insulation, device of protection class 2
	CE conformity mark. The device fulfills the requirements of the applicable EC directives.
	Products with this mark comply with both the Canadian (CSA) and the American (UL) requirements
	Caution! General hazard point. Read the operating instructions.
	General symbol: Input
	General symbol: Output
	General symbol: Power supply
CAT III	Measurement category CAT III for current and voltage inputs

Connecting modes

System/application	Terminals																	
Single phase AC system 																		
3-wire 3-phase symmetric load I: L1 																		
Connect the voltage according to the following table for current measurement in L2 or L3:																		
<table border="1"> <thead> <tr> <th>Current transf.</th> <th>Terminals</th> <th>2</th> <th>5</th> <th>8</th> </tr> </thead> <tbody> <tr> <td>L2</td> <td>1</td> <td>3</td> <td>L2</td> <td>L3</td> <td>L1</td> </tr> <tr> <td>L3</td> <td>1</td> <td>3</td> <td>L3</td> <td>L1</td> <td>L2</td> </tr> </tbody> </table>	Current transf.	Terminals	2	5	8	L2	1	3	L2	L3	L1	L3	1	3	L3	L1	L2	
Current transf.	Terminals	2	5	8														
L2	1	3	L2	L3	L1													
L3	1	3	L3	L1	L2													

System/application

Terminals

4-wire 3-phase symmetric load
I: L1

40.00

Connect the voltage according to the following table for current measurement in L2 or L3:

Current transf.	Terminals	2	11	
L2	1	3	L2	N
L3	1	3	L3	N

System/application

Terminals

3-wire 3-phase asymmetric load

30.00

3 single-pole insulated voltage transformers in high-voltage system

System/application

Terminals

3-wire 3-phase asymmetric load, Aron

30.00

System/application

Terminals

4-wire 3-phase asymmetric load

40.00

3 single-pole insulated voltage transformers in high-voltage system

System/application

Terminals

4-wire 3-phase asymmetric load, Open-Y

40.00

2 single-pole insulated voltage transformers in high-voltage system

Measured value display

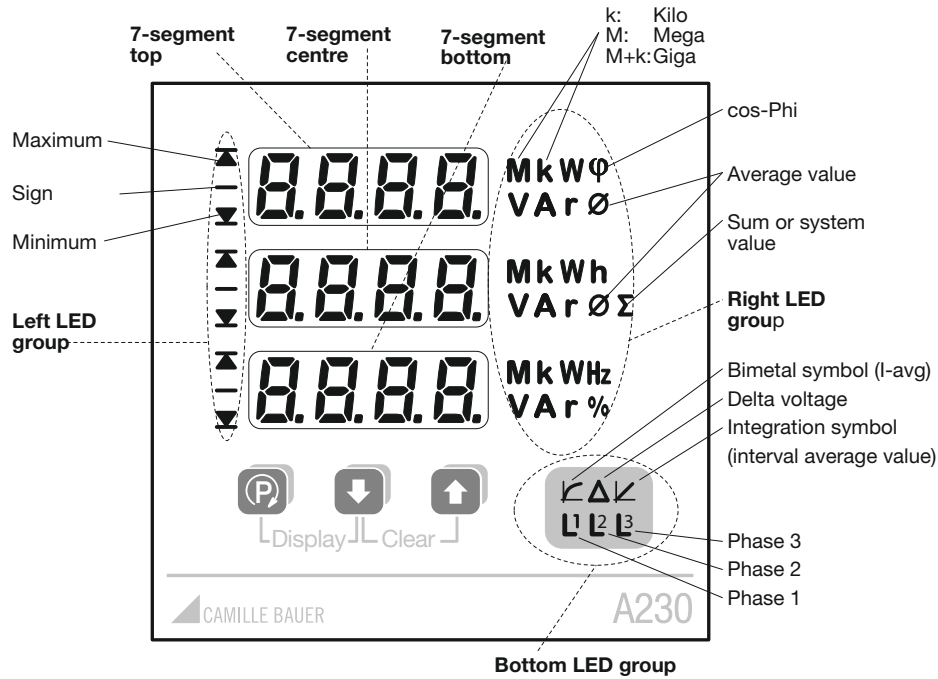

Abbreviations and symbols

oL	Overload, out of range indicator
U.nE	Neutral point voltage shift (U neutral-earth)
unb.U	Voltage asymmetry factor (unbalance U)
in	Neutral current
SYSt.	System power
x.xx i φ	Power factor incoming inductive
x.xx c φ	Power factor incoming capacitive
-x.xx i φ	Power factor outgoing inductive
-x.xx c φ	Power factor outgoing capacitive
inc	Incoming
out	Outgoing

ind	Inductive
CAP	Capacitive
.H	Energy high tariff
.L	Energy low tariff
thd.U	THD-U
thd.i	THD-I
trnd	Interval power: Trend
t-0...t-4	Interval power: last to fifth last interval
H2.U...H15.U	2 nd - 15 th harmonic U
H2.i...H15.i	2 nd - 15 th harmonic I

Available measurement data (at connection mode 4-wire asymmetric load)	LED group left (t c b)	Example 7-segm. display top	Example 7-segm. display centre	Example 7-segm. display bottom	LED group right	LED group bottom
Phase voltages: U1, U2, U3		230.2	231.1	229.9	V	L1 L2 L3
Maximum values: U1-max, U2-max, U3-max	▲ ▲ ▲	235.1	236.4	231.2	V	L1 L2 L3
Minimum values: U1-min, U2-min, U3-min	▼ ▼ ▼	227.8	226.6	225.7	V	L1 L2 L3
Delta voltages: U12, U23, U31		400.0	402.5	398.4	V	Δ
Maximum values: U12-max, U23-max, U31-max	▲ ▲ ▲	405.2	406.4	403.3	V	Δ
Minimum values: U12-min, U23-min, U31-min	▼ ▼ ▼	395.5	397.4	396.8	V	
Neutral point voltage shift: UNE and UNE-max	▲	U.nE	2.3	8.6	V	
Voltage asymmetry factor (unbalanced U)	▲	unb.U	1.4	6.2	%	
Phase currents: I1, I2, I3		11.54	10.98	10.23	A	L1 L2 L3
Maximum values: I1-max, I2-max, I3-max	▲ ▲ ▲	12.65	11.86	11.07	A	L1 L2 L3
Average values: I1avg, I2avg, I3avg (bimetal-15minutes)		7.23	6.86	6.46	A	⌋ L1 L2 L3
Max. average values: I1avg-max, I2avg-max, I3avg-max (slave pointer -15 minutes)	▲ ▲ ▲	7.98	7.48	6.98	A	⌋ L1 L2 L3
Neutral current: IN and IN-max	▲	in	1.13	2.75	A	
Active power: P1, P2, P3		a) 2240	2032	1491	W	L1 L2 L3
Maximum values: P1-max, P2-max, P3-max	▲ ▲ ▲ a)	2554	2825	2482	W	L1 L2 L3

Continuation see next page!

Available measurement data (at connection mode 4-wire asymmetric load)	LED group left	Example 7-segm. display top	Example 7-segm. display centre	Example 7-segm. display bottom	LED group right	LED group bottom
	(t c b)					
Active power system: P and P-max	▲ a)	5Y5t.	5.76	7.86	kW	
Reactive power: Q1, Q2, Q3	b)	1078	393	721	VAr	L1 L2 L3
Maximum values: Q1-max, Q2-max, Q3-max	▲ ▲ ▲ b)	1704	561	1027	VAr	L1 L2 L3
Reactive power system: Q and Q-max	▲ b)	5Y5t.	2.19	3.29	kVAr	
Apparent powers: S1, S2, S3		2281	2157	2089	VA	L1 L2 L3
Maximum values: S1-max, S2-max, S3-max	▲ ▲ ▲	3066	2874	2682	VA	L1 L2 L3
Apparent power system: S and S-max	▲	5Y5t.	6.64	8.11	kVA	
Power factors: PF1, PF2, PF3	a)	0.82c	0.97c	0.92c	φ	L1 L2 L3
PF-system, PF-min-inductive-incoming, PF-min-capacitive-incoming	a) ▼ ▼	0.90c	---	0.72c	φ	
PF-system, PF-min-inductive-outgoing, PF-min-capacitive-outgoing	a) - - ▼ ▼	0.90c	---	---	φ	
Frequency: F-max, F-actual, F-min	▲ ▼	50.14	50.03	49.78	Hz	
Active power incoming EP high tariff		4589	2356	inc.H	kWh Σ	
Active power incoming EP low tariff	c)	1234	5678	inc.L	kWh Σ	
Active power outgoing EP high tariff		4589	2356	out.H	kWh Σ	
Active power outgoing EP low tariff	c)	1234	5678	out.L	kWh Σ	
Reactive power inductive EQ high tariff	d)	9876	5432	ind.H	kVarh Σ	
Reactive power inductive EQ low tariff	c) d)	1234	9876	ind.L	kVarh Σ	
Reactive power capacitive EQ high tariff	d)	76	5432	CAP.H	kVarh Σ	
Reactive power capacitive EQ low tariff	c) d)	234	9876	CAP.L	kVarh Σ	
Reactive power incoming EQ high tariff	e)	9876	5432	inc.H	kVarh Σ	
Reactive power incoming EQ low tariff	c) e)	1234	9876	inc.L	kVarh Σ	
Reactive power outgoing EQ high tariff	e)	76	5432	out.H	kVarh Σ	
Reactive power outgoing EQ low tariff	c) e)	234	9876	out.L	kVarh Σ	
P-system, Q-system, S-system		5.76	2.19	6.64	kW kVAr kVA	
Average U1-U2-U3, average I1-I2-I3, P-system		230.4	10.92	5.76	VØ AØ kW	
PF-system, P-system, Q-system		0.90c	5.76	2.19	φ kW kVAr	
P-system, S-system, frequency		5.76	6.64	50.03	kW kVA Hz	
P1, Q1, S1		2240	1078	2485	W VAr VA	L1
P2, Q2, S2		2032	393	2070	W VAr VA	L2
P3, Q3, S3		1491	721	2089	W VAr VA	L3
U1, I1, P1		230.2	11.54	2240	V A W	L1
U2, I2, P2		231.1	10.98	2032	V A W	L2
U3, I3, P3		229.9	10.23	1491	V A W	L3
THD-U1, THD-U1-max	▲	thd.U	2.5	8.0	%	L1
THD-U2, THD-U2-max	▲	thd.U	2.6	8.3	%	L2
THD-U3, THD-U3-max	▲	thd.U	2.4	3.9	%	L3
THD-I1, THD-I1-max	▲	thd.I	2.4	10.8	%	L1
THD-I2, THD-I2-max	▲	thd.I	2.5	9.5	%	L2
THD-I3, THD-I3-max	▲	thd.I	2.4	4.6	%	L3
Interval active power: Trend-incoming		P.inc	5.23	trnd	kW Σ	↙
Interval active power: Maximum-incoming Minimum-incoming	▲ ▼	P.inc	6.02	1.56	kW Σ	↙
Interval active power: last interval (t-0) incoming to fifth last interval (t-4) incoming		P.inc	3.91	t-0 to t-4	kW Σ	↙
Interval active power: Trend-outgoing		P.out	0.00	trnd	kW Σ	↘
Interval active power: Maximum-outgoing Minimum-outgoing	▲ ▼	P.out	0.00	0.00	kW Σ	↘
Interval active power: last interval (t-0) outgoing to fifth last interval (t-4) outgoing		P.out	0.00	t-0 to t-4	kW Σ	↘

Continuation see next page!

Available measurement data (at connection mode 4-wire asymmetric load)	LED group left		Example 7-segm. display top	Example 7-segm. display centre	Example 7-segm. display bottom	LED group right	LED group bottom	
	(t	c	b)					
Interval react. power: Trend-inductive				Q.ind	0.00	trnd	kVAr Σ	↙
Interval react. power: Maximum-inductive Minimum-inductive	↗	↘		Q.ind	0.00	0.00	kVAr Σ	↙
Interval react. power: last interval (t-0) inductive to fifth last interval (t-4) inductive				Q.ind	0.00	t-0 to t-4	kVAr Σ	↙
Interval react. power: Trend-capacitive				Q.cap	2.17	trnd	kVAr Σ	↙
Interval react. power: Maximum-cap., Minimum-cap.	↗	↘		Q.cap	2.53	0.78	kVAr Σ	↙
Interval react. power: last interval (t-0) capacitive to fifth last interval (t-4) capacitive				Q.cap	1.41	t-0 to t-4	kVAr Σ	↙
Interval react. power: Trend-incoming				Q.inc	2.17	trnd	kVAr Σ	↙
Interval react. power: Maximum-incoming Minimum-incoming	↗	↘		Q.inc	2.53	0.78	kVAr Σ	↙
Interval react. power: last interval (t-0) incoming to fifth last interval (t-4) incoming				Q.inc	1.41	t-0 to t-4	kVAr Σ	↙
Interval react. power: Trend-outgoing				Q.out	0.00	trnd	kVAr Σ	↙
Interval react. power: Maximum-outgoing Minimum-outgoing	↗	↘		Q.out	0.00	0.00	kVAr Σ	↙
Interval react. power: last interval (t-0) outgoing to fifth last interval (t-4) outgoing				Q.out	0.00	t-0 to t-4	kVAr Σ	↙
Interval appar. power: Trend				S	5.23	trnd	kVA Σ	↙
Interval appar. power: Maximum, Minimum	↗	↘		S	6.02	1.56	kVA Σ	↙
Interval appar. power: last interval (t-0) to fifth last interval (t-4)				S	3.91	t-0 to t-4	kVA Σ	↙
2nd harmonic U1: H2-U1, H2-U1-max to	↗			H2.U	0.1	1.2	%	L1
15th harmonic U1: H15-U1, H15-U1-max	↗			H15.U	0.5	1.8	%	L1
2nd harmonic U2: H2-U2, H2-U2-max to	↗			H2.U	0.1	0.4	%	L2
15th harmonic U2: H15-U2, H15-U2-max	↗			H15.U	0.7	2.0	%	L2
2nd harmonic U3: H2-U3, H2-U3-max to	↗			H2.U	0.2	1.5	%	L2
15th harmonic U3: H15-U3, H15-U3-max	↗			H15.U	1.5	2.8	%	L2
2nd harmonic I1: H2-I1, H2-I1-max to	↗			H2.I	0.4	2.2	%	L1
15th harmonic I1: H15-I1, H15-I1-max	↗			H15.I	0.9	4.8	%	L1
2nd harmonic I2: H2-I2, H2-I2-max to	↗			H2.I	0.3	1.8	%	L2
15th harmonic I2: H15-I2, H15-I2-max	↗			H15.I	0.8	5.2	%	L2
2nd harmonic I3: H2-I3, H2-I3-max to	↗			H2.I	0.5	3.2	%	L2
15th harmonic I3: H15-I3, H15-I3-max	↗			H15.I	1.1	5.8	%	L2

- a) incoming: no sign Outgoing: sign –
b) incoming inductive, outgoing capacitive: no sign
incoming capacitive, outgoing inductive: sign –
c) Tariff switching via digital input or controlled via the bus only (optional extension module required)

- d) only active if the Q definition is set to "ind/cap" (display configuration **7** : Q.tot)
e) only active if the Q definition is set to "inc/out" (display configuration **7** : Q.tot)

Determination of measured quantities

The calculation of the measurements is made in accordance with DIN 40 110, with the exception of the reactive power. This is calculated by the SINEAX A 230/A 230s as a signed value. Transducers and displays can possibly display different values for the reactive power in the same power system. The reason is the different calculation methods.

Trend values display the predicted value for the current interval.

Example: Power factor 4 quadrant display

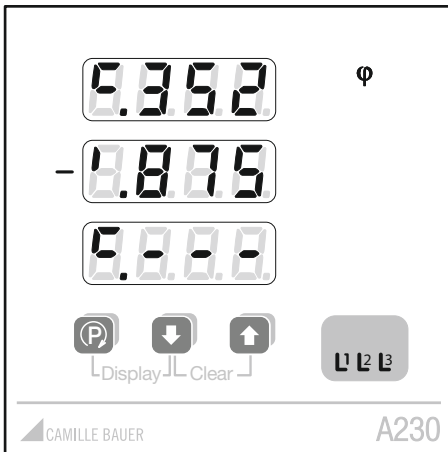

PF-L1, PF-L2, PF-L3 actual

(Matrix table 4-wire asymmetric load: field a-6)

Actual power factors per phase:

top: PF L1 = incoming / capacitive / 0.352

centre: PF L2 = outgoing / inductive / 0.875

bottom: PF L3 = cannot be measured

(---: apparent power < 1% of nominal input power
→ PF cannot be measured)

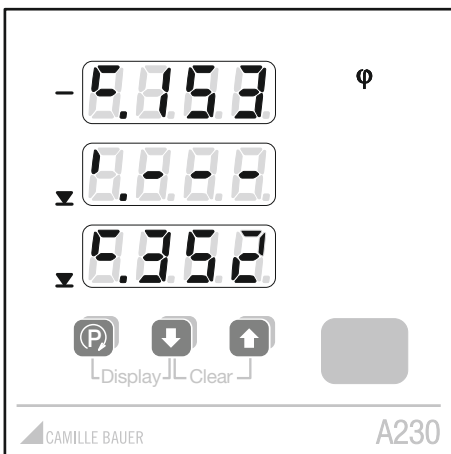

PF-system-actual and PF-min-incoming

(Matrix table 4-wire asymmetric load: field b-6)

top: PF system actual = outgoing / capacitive / 0.153

(---: apparent power < 1% of nominal input power
→ PF cannot be measured)

centre: PF minimum incoming inductive = no measuring value

bottom: PF minimum incoming capacitive = 0.352

(minimum: lowest value of PF1, PF2 or PF3)

(---: no measured value in the quadrants concerned)

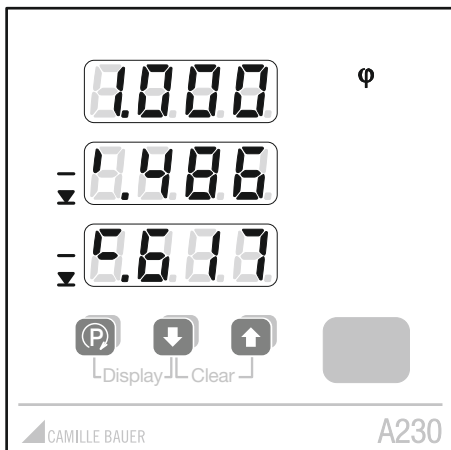

PF-system-actual and PF-min-outgoing

(Matrix table 4-wire asymmetric load: field c-6)

top: PF system actual = incoming / — / 1.000

(---: apparent power < 1% of nominal input power
→ PF cannot be measured)

centre: PF minimum outgoing inductive = 0.486

bottom: PF minimum outgoing capacitive = 0.617

(Minimum: lowest value of PF1, PF2 or PF3)

(---: no measured value in the quadrants concerned)

Display modes

FULL

All the display values in accordance with the matrix tables can be displayed (factory setting).

USER

Only the pre-configured display values are displayed. The factory pre-configured values are shown in the matrix tables with a gray-background.

LOOP

Automatically changing display. The display time, and the values to be displayed are pre-configurable.

The factory pre-configured values are shown in the matrix tables with a bold outline. The factory setting for the display time is 4 seconds.

Preferred display

You may select a preferred display which is displayed automatically after a certain time without user interaction. So the normal appearance of the device is always the same. There are two different possibilities to define a preferred display.

Preferred display in Loop mode

In Loop mode a display can be set which should be displayed normally all the time. In addition, any other value can be selected as for the full mode. After the reset time period (2 - 32 s), the display automatically returns to the preferred display.

Configuration

The Loop mode is blocked with the mode lock **17**. The reset time is configured with the display interval configuration **18**. Set the required window to "on" in the display configuration under No. **20** (Menu Disp). Set all the other display elements to "off".

Preferred display in User-Modus

Only the User mode is active. Out of the displayable displays a preferred display can be selected, which is automatically displayed after a predefined time without user interaction. All other display contents may be directly displayed using the keys. The delay until the preferred display is shown is 4 min. for version 4.00 resp. 10 min. starting from version 4.01 of the basic device.

Configuration

The User mode is blocked with the mode lock **17**. Use the keys to show the display which should serve as the preferred display and set it as the preferred display by pressing the keys **P** and **↑** at the same time. The same procedure may be used to switch-off the preferred display. The displays which should be displayable in the User mode may be set to "on" in the menu Menu Disp under No. **21**. All other elements should be set to "off".

Duration of the display

It may be difficult to read the measured values when they change quickly. Therefore the write interval can be increased in the menu "Display settings".

Operation

Changing the display mode

By simultaneously pressing the buttons **P** and **↓** (display) for a longer time, the display mode changes and then remains in the last mode displayed when the buttons are released (factory setting: FULL). If the mode cannot be changed, the mode lock is switched on.

Locking

In the display configuration menu (Menu Disp), changing the display modes can be blocked with the mode lock **16**.

Navigation

X axis (a, b, c, ...)

For each pressing of the **P** button, the displayed value changes in accordance with the preconfiguration and matrix table one window towards the right and loops back to the beginning.

Y axis (1, 2, 3, ...)

For each pressing of the **↑** or **↓** buttons, the displayed value changes in accordance with the preconfiguration and matrix table one window upwards as far as the top window or respectively one window downwards as far as the bottom window.

Brightness (13 levels)

brighter Press the key **↑** for a longer time.

darker Press the key **↓** for a longer time.

Deletion of the max./min. values and meters

Simultaneous longer pressing of the **↑** and **↓** buttons (clear) deletes the max. respectively min. values of the measured value displayed and the associated values. The energy meters are reset in the same way.

Locking

The reset function for the energy meters can be locked by setting the jumper at the rear of the instrument to the position LOCK.

Display window

▲ = Maximum, ▼ = Minimum

Matrix table 4L, asymmetric load

Q measured values are in *italics*: depending on the Q definition **7**, either the values for incoming/outgoing or the values for inductive/capacitive are displayed.

	a	b	c	d	e	f	g	h						
1	U1 U2 U3	U1 ▲ U2 ▲ U3 ▲	U1 ▼ U2 ▼ U3 ▼	U12 U23 U31	U12 ▲ U23 ▲ U31 ▲	U12 ▼ U23 ▼ U31 ▼	UNE UNE ▲	unb. U unb. U ▲						
2	I1 I2 I3	I1 ▲ I2 ▲ I3 ▲	I1avg I2avg I3avg	I1avg ▲ I2avg ▲ I3avg ▲	IN IN ▲									
3	P1 P2 P3	P1 ▲ P2 ▲ P3 ▲	P P ▲											
4	Q1 Q2 Q3	Q1 ▲ Q2 ▲ Q3 ▲	Q Q ▲											
5	S1 S2 S3	S1 ▲ S2 ▲ S3 ▲	S S ▲											
6	PF1 PF2 PF3	PF PF ▼-inc-ind PF ▼-inc-cap	PF PF ▼-out-ind PF ▼-out-cap											
7	F ▲ F F ▼													
8 EP_inc HT EP_inc LT EP_out HT EP_out LT										
9 EQ_inc/ind HT EQ_inc/ind LT EQ_out/cap HT EQ_out/cap LT										
10	P Q S	U Ø I Ø P	PF P Q	P S F										
11	P1 Q1 S1	P2 Q2 S2	P3 Q3 S2	U1 I1 P1	U2 I2 P2	U3 I3 P3								
12	thd.U1 thd.U1 ▲	thd.U2 thd.U2 ▲	thd.U3 thd.U3 ▲											
13	thd.I1 thd.I1 ▲	thd.I2 thd.I2 ▲	thd.I3 thd.I3 ▲											
14	P.inc-int-Trend	P.inc-int- ▲ P.inc-int- ▼	P.inc-int t-0	P.inc-int t-1	P.inc-int t-2	P.inc-int t-3	P.inc-int t-4							
15	P.out-int-Trend	P.out-int- ▲ P.out-int- ▼	P.out-int t-0	P.out-int t-1	P.out-int t-2	P.out-int t-3	P.out-int t-4							
16	Q.inc/ind-int-Trend	Q.inc/ind-int- ▲ Q.inc/ind-int- ▼	Q.inc/ind-int t-0	Q.inc/ind-int t-1	Q.inc/ind-int t-2	Q.inc/ind-int t-3	Q.inc/ind-int t-4							
17	Q.out/cap-int-Trend	Q.out/cap-int- ▲ Q.out/cap-int- ▼	Q.out/cap-int t-0	Q.out/cap-int t-1	Q.out/cap-int t-2	Q.out/cap-int t-3	Q.out/cap-int t-4							
18	S.int-Trend	S.int- ▲ S.int- ▼	S.int t-0	S.int t-1	S.int t-2	S.int t-3	S.int t-4							
	a	b	c	d	e	f	g	h	i	j	k	l	m	n
19	H2.U1 H2▲.U1	H3.U1 H3▲.U1	H4.U1 H4▲.U1	H5.U1 H5▲.U1	H6.U1 H6▲.U1	H7.U1 H7▲.U1	H8.U1 H8▲.U1	H9.U1 H9▲.U1	H10.U1 H10▲.U1	H11.U1 H11▲.U1	H12.U1 H12▲.U1	H13.U1 H13▲.U1	H14.U1 H14▲.U1	H15.U1 H15▲.U1
20	H2.U2 H2▲.U2	H3.U2 H3▲.U2	H4.U2 H4▲.U2	H5.U2 H5▲.U2	H6.U2 H6▲.U2	H7.U2 H7▲.U2	H8.U2 H8▲.U2	H9.U2 H9▲.U2	H10.U2 H10▲.U2	H11.U2 H11▲.U2	H12.U2 H12▲.U2	H13.U2 H13▲.U2	H14.U2 H14▲.U2	H15.U2 H15▲.U2
21	H2.U3 H2▲.U3	H3.U3 H3▲.U3	H4.U3 H4▲.U3	H5.U3 H5▲.U3	H6.U3 H6▲.U3	H7.U3 H7▲.U3	H8.U3 H8▲.U3	H9.U3 H9▲.U3	H10.U3 H10▲.U3	H11.U3 H11▲.U3	H12.U3 H12▲.U3	H13.U3 H13▲.U3	H14.U3 H14▲.U3	H15.U3 H15▲.U3
22	H2.I1 H2▲.I1	H3.I1 H3▲.I1	H4.I1 H4▲.I1	H5.I1 H5▲.I1	H6.I1 H6▲.I1	H7.I1 H7▲.I1	H8.I1 H8▲.I1	H9.I1 H9▲.I1	H10.I1 H10▲.I1	H11.I1 H11▲.I1	H12.I1 H12▲.I1	H13.I1 H13▲.I1	H14.I1 H14▲.I1	H15.I1 H15▲.I1
23	H2.I2 H2▲.I2	H3.I2 H3▲.I2	H4.I2 H4▲.I2	H5.I2 H5▲.I2	H6.I2 H6▲.I2	H7.I2 H7▲.I2	H8.I2 H8▲.I2	H9.I2 H9▲.I2	H10.I2 H10▲.I2	H11.I2 H11▲.I2	H12.I2 H12▲.I2	H13.I2 H13▲.I2	H14.I2 H14▲.I2	H15.I2 H15▲.I2
24	H2.I3 H2▲.I3	H3.I3 H3▲.I3	H4.I3 H4▲.I3	H5.I3 H5▲.I3	H6.I3 H6▲.I3	H7.I3 H7▲.I3	H8.I3 H8▲.I3	H9.I3 H9▲.I3	H10.I3 H10▲.I3	H11.I3 H11▲.I3	H12.I3 H12▲.I3	H13.I3 H13▲.I3	H14.I3 H14▲.I3	H15.I3 H15▲.I3

Matrix table 3L, asymmetric load

▲ = Maximum, ▼ = Minimum

Q measured values are in italics: depending on the Q definition **7**, either the values for incoming/outgoing or the values for inductive/capacitive are displayed.

	a	b	c	d	e	f	g	
1	U12 U23 U31	U12 ▲ U23 ▲ U31 ▲	U12 ▼ U23 ▼ U31 ▼					
2	I1 I2 I3	I1 ▲ I2 ▲ I3 ▲	I1avg I2avg I3avg	I1avg ▲ I2avg ▲ I3avg ▲				
3	P P ▲							
4	Q Q ▲							
5	S S ▲							
6	PF PF ▼-inc-ind PF ▼-inc-cap	PF PF ▼-out-ind PF ▼-out-cap						
7	F ▲ F F ▼							
8 EP_inc HT EP_inc LT EP_out HT EP_out LT				
9 EQ inc/ind HT EQ inc/ind LT EQ out/cap HT EQ out/cap LT				
10	P Q S	U Ø I Ø P	PF P Q	P S F				
11	thd.U12 thd.U12 ▲	thd.U23 thd.U23 ▲	thd.U31 thd.U31 ▲					
12	thd.I1 thd.I1 ▲	thd.I2 thd.I2 ▲	thd.I3 thd.I3 ▲					
13	P.inc-int-Trend	P.inc-int- ▲ P.inc-int- ▼	P.inc-int t-0	P.inc-int t-1	P.inc-int t-2	P.inc-int t-3	P.inc-int t-4	
14	P.out-int-Trend	P.out-int- ▲ P.out-int- ▼	P.out-int t-0	P.out-int t-1	P.out-int t-2	P.out-int t-3	P.out-int t-4	
15	Q.inc/ind-int-Trend	Q.inc/ind-int- ▲ Q.inc/ind-int- ▼	Q.inc/ind-int t-0	Q.inc/ind-int t-1	Q.inc/ind-int t-2	Q.inc/ind-int t-3	Q.inc/ind-int t-4	
16	Q.out/cap-int-Trend	Q.out/cap-int- ▲ Q.out/cap-int- ▼	Q.out/cap-int t-0	Q.out/cap-int t-1	Q.out/cap-int t-2	Q.out/cap-int t-3	Q.out/cap-int t-4	
17	S.int-Trend	S.int- ▲ S.int- ▼	S.int t-0	S.int t-1	S.int t-2	S.int t-3	S.int t-4	

	a	b	c	d	e	f	g	h	i	j	k	l	m	n	
18	H2.U12 H2▲.U12	H3.U12 H3▲.U12	H4.U12 H4▲.U12	H5.U12 H5▲.U12	H6.U12 H6▲.U12	H7.U12 H7▲.U12	H8.U12 H8▲.U12	H9.U12 H9▲.U12	H10.U12 H10▲.U12	H11.U12 H11▲.U12	H12.U12 H12▲.U12	H13.U12 H13▲.U12	H14.U12 H14▲.U12	H15.U12 H15▲.U12	
19	H2.U23 H2▲.U23	H3.U23 H3▲.U23	H4.U23 H4▲.U23	H5.U23 H5▲.U23	H6.U23 H6▲.U23	H7.U23 H7▲.U23	H8.U23 H8▲.U23	H9.U23 H9▲.U23	H10.U23 H10▲.U23	H11.U23 H11▲.U23	H12.U23 H12▲.U23	H13.U23 H13▲.U23	H14.U23 H14▲.U23	H15.U23 H15▲.U23	
20	H2.U31 H2▲.U31	H3.U31 H3▲.U31	H4.U31 H4▲.U31	H5.U31 H5▲.U31	H6.U31 H6▲.U31	H7.U31 H7▲.U31	H8.U31 H8▲.U31	H9.U31 H9▲.U31	H10.U31 H10▲.U31	H11.U31 H11▲.U31	H12.U31 H12▲.U31	H13.U31 H13▲.U31	H14.U31 H14▲.U31	H15.U31 H15▲.U31	
21	H2.I1 H2▲.I1	H3.I1 H3▲.I1	H4.I1 H4▲.I1	H5.I1 H5▲.I1	H6.I1 H6▲.I1	H7.I1 H7▲.I1	H8.I1 H8▲.I1	H9.I1 H9▲.I1	H10.I1 H10▲.I1	H11.I1 H11▲.I1	H12.I1 H12▲.I1	H13.I1 H13▲.I1	H14.I1 H14▲.I1	H15.I1 H15▲.I1	
22	H2.I2 H2▲.I2	H3.I2 H3▲.I2	H4.I2 H4▲.I2	H5.I2 H5▲.I2	H6.I2 H6▲.I2	H7.I2 H7▲.I2	H8.I2 H8▲.I2	H9.I2 H9▲.I2	H10.I2 H10▲.I2	H11.I2 H11▲.I2	H12.I2 H12▲.I2	H13.I2 H13▲.I2	H14.I2 H14▲.I2	H15.I2 H15▲.I2	
23	H2.I3 H2▲.I3	H3.I3 H3▲.I3	H4.I3 H4▲.I3	H5.I3 H5▲.I3	H6.I3 H6▲.I3	H7.I3 H7▲.I3	H8.I3 H8▲.I3	H9.I3 H9▲.I3	H10.I3 H10▲.I3	H11.I3 H11▲.I3	H12.I3 H12▲.I3	H13.I3 H13▲.I3	H14.I3 H14▲.I3	H15.I3 H15▲.I3	

Matrix table single phase, 3L and 4L symmetric load

▲ = Maximum, ▼ = Minimum

Q measured values are in italics: depending on the Q definition **7**, either the values for incoming/outgoing or the values for inductive/capacitive are displayed.

		a	b	c	d	e	f	g							
1	U ▲ U U ▼														
2	I I ▲	lavg lavg ▲													
3	P P ▲														
4	Q Q ▲														
5	S S ▲														
6	PF PF ▼-inc-ind PF ▼-inc-cap	PF PF ▼-out-ind PF ▼-out-cap													
7	F ▲ F F ▼														
8	EP_inc HT	EP_inc LT	EP_out HT	EP_out LT											
9	EQ_inc/ind HT	EQ_inc/ind LT	EQ_out/cap HT	EQ_out/cap LT											
10	P Q S	U I P	PF P Q	P S F											
11	thd.U thd.U ▲														
12	thd.I thd.I ▲														
13	P.inc-int-Trend	P.inc-int- ▲ P.inc-int- ▼	P.inc-int t-0	P.inc-int t-1	P.inc-int t-2	P.inc-int t-3	P.inc-int t-4								
14	P.out-int-Trend	P.out-int- ▲ P.out-int- ▼	P.out-int t-0	P.out-int t-1	P.out-int t-2	P.out-int t-3	P.out-int t-4								
15	Q.inc/ind-int-Trend	Q.inc/ind-int- ▲ Q.inc/ind-int- ▼	Q.inc/ind-int t-0	Q.inc/ind-int t-1	Q.inc/ind-int t-2	Q.inc/ind-int t-3	Q.inc/ind-int t-4								
16	Q.out/cap-int-Trend	Q.out/cap-int- ▲ Q.out/cap-int- ▼	Q.out/cap-int t-0	Q.out/cap-int t-1	Q.out/cap-int t-2	Q.out/cap-int t-3	Q.out/cap-int t-4								
17	S.int-Trend	S.int- ▲ S.int- ▼	S.int t-0	S.int t-1	S.int t-2	S.int t-3	S.int t-4								
		a	b	c	d	e	f	g	h	i	j	k	l	m	n
18	H2.U H2 ▲.U	H3.U H3 ▲.U	H4.U H4 ▲.U	H5.U H5 ▲.U	H6.U H6 ▲.U	H7.U H7 ▲.U	H8.U H8 ▲.U	H9.U H9 ▲.U	H10.U H10 ▲.U	H11.U H11 ▲.U	H12.U H12 ▲.U	H13.U H13 ▲.U	H14.U H14 ▲.U	H15.U H15 ▲.U	
19	H2.I H2 ▲.I	H3.I H3 ▲.I	H4.I H4 ▲.I	H5.I H5 ▲.I	H6.I H6 ▲.I	H7.I H7 ▲.I	H8.I H8 ▲.I	H9.I H9 ▲.I	H10.I H10 ▲.I	H11.I H11 ▲.I	H12.I H12 ▲.I	H13.I H13 ▲.I	H14.I H14 ▲.I	H15.I H15 ▲.I	

Programming (Programming diagram on page 18)

All parameter may be displayed at any time. For modifications the jumper on the backside of the device must be removed (not on position LOCK).

- (1) Change from the display level to the menu level by pressing the **(P)** button for a longer time.
- (2) Select the required menu item by pressing the **(P)** button for a shorter time.
- (3) Use **(↓)** to enter the level where the desired parameter is displayed.
- (4) Pressing **(P)** shortly will force the selectable element to flash.
- (5) The flashing content may be modified using the keys **(↓)** or **(↑)**.
- (6) To acknowledge, shortly press the **(P)** button.
- (7) If the next 7-segment display, the decimal point, or a unit flashes: continue at (5).
- (8) If additional parameters are to be modified at the same menu item, change to the required parameter with the **(↓)** or **(↑)** buttons and continue at (4).
- (9) If modifications are to be made in other menu columns, return to the menu level with the **(↑)** button, and continue at (2).
- (10) Return to the display level by pressing the **(P)** button for a longer time.

The navigation steps for the selection of display elements under "Menu Disp" differ from the above description between points (4) and (8) (see configuration diagram Nos. **20** and **22**).

Hints

All settings will remain non-volatile stored even in case of power-fail.

First you have to set the system configuration, the transformer ratios and the Q definition because further measurand selections, alarm limit settings etc. will depend on them.

As an alternative to the configuration of the various options with the display buttons, they can be configured comfortably with the A200plus software (with the extension module EMMOD 201 and EMMOD 203). The data can be stored on the PC and used later.

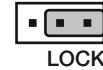

LOCK

Locking the configuration

Place the jumper in the LOCK position.

The configuration of all parameters is disabled.

Factory Default

Jumper:	not in the LOCK position
Connecting mode:	4-wire asymmetric load
Transformer ratio:	1:1
Q definition:	inductive / capacitive
Limit value / S01:	Off
Limit value / S02:	Off
Synchronizing interval:	15 min.
Display mode:	FULL, duration of the display 0.0 s
Brightness:	middle value













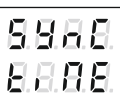

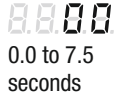
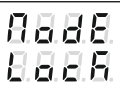





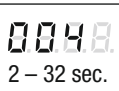
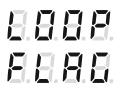







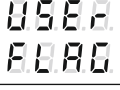

Overview of the parameters

The following table gives all the parameters together with their adjustable ranges or the possible selections. The numbers with a black background (xx) give a reference to the corresponding positions in the navigation diagram on page 18.

No.	Topmost display	Undermost display	Meaning	Hints
1			System configuration	
			4-line system, unbalanced load, Open-Y	(4 lines unbalanced, Open-Y)
			4-line system, unbalanced load	(4 lines unbalanced)
			3-line system, unbalanced load, Aron	(3 lines unbalanced, Aron)
			3-line system, unbalanced load	(3 lines unbalanced)
			4-line system, balanced load	(4 lines balanced)
			3-line system, balanced load	(3 lines balanced)
2			Load type for energy recovery: Mathematical	4 quadrant display, ind-cap-ind-cap
			Load type for energy recovery: Electrical	4 quadrant display, ind-ind-cap-cap
3			Primary voltage of an external transformer on the voltage input (line-to-line voltage)	First you enter any 3-digit number followed by the appropriate power unit selection in steps of factor 10.
		100 V to 999 kV		
4			Secondary voltage of an external transformer on the voltage input (line-to-line voltage)	
		100 V to 999 V		
5			Primary current of an external transformer on the current input	
		1.00 A to 999 kA		
6			Secondary current of an external transformer on the current input	
		0.1 A to 9,99 A		





No.	Topmost display	Undermost display	Meaning	Hints		
7	9.888		Q definition for meters, pulse outputs and power average values	(Q-totalizers)		
		8.888 8.888	Q-incoming Q-outgoing	(incoming) (outgoing)		
		8.888 8.888	Q-inductive Q-capacitive	(inductive) (capacitive)		
8	888.8 / .2 8888		Operating mode of both digital outputs "out.1" and "out.2"	(Mode)		
		8.888	Output switched-off	Simulation via interface module is still possible		
		8.005	Energy pulse output	The output generates energy pulses depending on the rate set under 14. The meter measurands to output may be selected under 13.		
		8.008	Alarm output	If the alarm limit 10 is exceeded the output will be active (current flows). If the measurand is below limit 11 the output will be passive. The source of the monitored is selected under 9.		
9	8.588		Alarm supervision source	This selection is presented only if operating mode 8 is set to ALM previously.		
				Line type '1L' '3Lb' '4Lb' '3Lu' '3Lu.A' '4Lu' '4Lu.0'		
		8.888 8.888 8.888 resp.	Q interval (Reactive power interval) (cap./outg. to Q-definition 7) Trend	•	•	•
		8.888 8.888	P interval outgoing (Active power interval) (Outgoing) Trend	•	•	•
		8.888 8.888	S interval (Apparent power interval) Trend	•	•	•
		8.888 8.888 8.888 resp.	Q interval (Reactive power interval) (ind./inc. to Q-definition 7) Trend	•	•	•
		8.888 8.888	P interval incoming (Active power interval) (Incoming) Trend	•	•	•
		8.888 8.888 8.888 resp.	Q interval (Reactive power interval) (cap./outg. to Q-definition 7)	•	•	•
		8.888 8.888	P interval outgoing (Active power interval) (Outgoing)	•	•	•
		8.88.0	unbalance U (Voltage asymmetry factor)			•
		0.888	U neutral-earth (Neutral point voltage shift)			•
		8.88.0	THD current	•	○	○
		8.88.0	THD voltage	•	○	○
		8.88.8	Frequency	•	•	•

No.	Topmost display	Undermost display	Meaning	Hints
9	8.588		Alarm supervision source (continuation)	Line type '1L' '3Lb' '4Lb' '3Lu' '3Lu.A' '4Lu' '4Lu.0'
		0.000	I neutral (Neutral current)	●
		5.000	S interval (Apparent power interval)	● ● ●
		9.000 0.000 0.000 resp.	Q interval (Reactive power interval) (ind./inc. to Q-definition 7)	● ● ●
		8.000 0.000	P interval incoming (Active power interval) (incoming)	● ● ●
		8.888	Power factor (cos-phi)	● ● ○
		5.888	Apparent power	● ● ○
		9.888	Reactive power	● ● ○
		8.888	Active power	● ● ○
		0.888	Voltage	●
		0.000	U Line-Neutral (Phase voltage)	○
		0.000	U Line-Line (Line to line voltage)	○ ○
		0.000	I Average (Phase current bimetal)	● ○ ○
		0.888	Phase current	● ○ ○
				○: 'A.on' = OR-operation of line-measurands 'A.off' = AND-operation of line-measurands
10	888.8 / .2 8.888	8.800 v	Alarm unit for ON-state	The maximum values of the alarm limits depend on the possible measuring range (fixed by hardware), converted into possible primary values given by the selected systemconfiguration and transformation ratios..
11	888.8 / .2 8.888	8.800 v	Alarm unit for OFF-state	
12	888.8 / .2 8.888	8.88.0	Switch-in and Dropout delay of the alarm	Range: 0.3 ... 999.9 s
13	888.8 / .2 E.588		Source of energy meters for pulse output	(Reactive energy acc. to Q definition 7)
		8.88.0 resp. 8.88.0	Reactive energy capacitive / outgoing low tariff	(capacitive low tariff) (outgoing low tariff)
		8.88.H resp. 8.88.H	Reactive energy capacitive / outgoing high tariff	(capacitive high tariff) (outgoing high tariff)
		8.88.0 resp. 8.88.0	Reactive energy inductive / incoming low tariff	(inductive low tariff) (incoming low tariff)
		8.88.H resp. 8.88.H	Reactive energy inductive / incoming high tariff	(inductive high tariff) (incoming high tariff)
		8.88.0	Active energy outgoing low tariff	(outgoing low tariff)
		8.88.H	Active energy outgoing high tariff	(outgoing high tariff)
		8.88.0	Active energy incoming low tariff	(incoming low tariff)
8.88.H	Active energy incoming high tariff	(incoming high tariff)		

No.	Topmost display	Undermost display	Meaning	Hints
14			Number of pulses per displayed energy unit. After entering a number from 1 to 5000 you may be input the scaling: Basic unit (-), kilog (k), Mega (M) or Giga (Mk)	(energy rate)
15			Time interval in minutes for the calculation of power intervals 0 = Interval controlled via the bus	For external synchronization, the value displayed is not relevant
16			Duration of the display To stabilize the display, the duration can be set to max. 7.5 s; in steps of 0.5 s	The set duration only affects the display.
17			Locking the change of the display mode	
			Only the Loop mode is enabled	Loop: Automatically changing pre-configured display values
			Only the User mode is enabled	User: Pre-configured display values
			Only the Full mode is enabled	Full: Full display values
			All display modes are enabled	
18			Display time in Loop mode	
19			Configuration of the display values in Loop mode	Enter 20 : Press de key  shortly
20			Position in the matrix table Display element on/off	See "matrix table" (page 10 to 12) Navigation X: Press  shortly Navigation Y: Press  or  shortly on/off: Press  and  for a longer time Exit: Press  for a longer time (back to 17)
21			Configuration of the display values in User mode	Enter 22 : Press  shortly
22			Position in the matrix table Display element on/off	See "matrix table" (page 10 to 12) Navigation X: Press  shortly Navigation Y: Press  or  shortly on/off: Press  and  for a longer time Exit: Press  for a longer time (back to 21)





Examples

Example 1: Programming the system configuration (3-line, unbalanced load)

1. Press **[P]** > 2 s

2. Press **[↓]** (present setting is displayed)

3. Press **[P]** (alterable parameter flashes)

4. Press **[↓]** / **[↑]** to select desired setting

5. Press **[P]** (takes over new setting).
 Display stops flashing

6. Press **[P]** > 2 s to return to display level

Example 2: Programming voltage transformer ratio and synchronization interval

1. Press **[P]** > 2 s

2. Press **[P]** (transformer ratio menu)

3. Press **[↓]** (present setting of primary voltage)

4. Press **[P]** (leftmost digit flashes)

5. Press **[↓]** / **[↑]** until desired number appears
6. Press **[P]** (middle digit flashes)
7. Press **[↓]** / **[↑]** until desired number appears
8. Press **[P]** (rightmost digit flashes)
9. Press **[↓]** / **[↑]** until desired number appears
10. Press **[P]** (decimal point flashes)
11. Press **[↓]** / **[↑]** until the decimal point is on the desired position and the kilo/Mega display is correct
12. Press **[P]** (takes over new value).
 The display stops flashing
13. Press **[↓]** (present setting of secondary voltage)

14. Programming procedure same as for primary voltage (1 to 12)

15. Press until the topmost display
 as shown
16. Press four times
17. Press (present setting of synchronization interval in minutes)

18. Press (left digit flashes)
19. Press / until desired number appears
20. Press (right digit flashes)
21. Press / until desired number appears
22. Press (takes over new value).
 The display stops flashing
23. Press > 2 s (return to display level)

Declaration of conformity SINEAX A230

	EG - KONFORMITÄTSERKLÄRUNG EC DECLARATION OF CONFORMITY		CAMILLE BAUER
Dokument-Nr./ Document.No.:	A230_CE-konf.DOC		
Hersteller/ Manufacturer:	Camille Bauer AG Switzerland		
Anschrift / Address:	Aargauerstrasse 7 CH-5610 Wohlen		
Produktbezeichnung/ Product name:	Multifunktionales Leistungsmessgerät mit Netzanalyse Multifunctional Power Monitor with System Analysis		
Typ / Type:	SINEAX A 230		
Das bezeichnete Produkt stimmt mit den Vorschriften folgender Europäischer Richtlinien überein, nachgewiesen durch die Einhaltung folgender Normen:			
The above mentioned product has been manufactured according to the regulations of the following European directives proven through compliance with the following standards:			
Nr. / No.	Richtlinie / Directive		
2004/108/EG 2004/108/EC	Elektromagnetische Verträglichkeit - EMV-Richtlinie Electromagnetic compatibility - EMC directive		
EMV / EMC	Fachgrundnorm / Generic Standard	Messverfahren / Measurement methods	
Störaussendung / Emission	EN 61000-6-4 : 2007	EN 55011 : 2007+A2:2007	
Störfestigkeit / Immunity	EN 61000-6-2 : 2005	IEC 61000-4-2: 1995+A1:1998+A2:2001 IEC 61000-4-3: 2006+A1:2007 IEC 61000-4-4: 2004 IEC 61000-4-5: 2005 IEC 61000-4-6: 2008 IEC 61000-4-8: 1993+A1:2000 IEC 61000-4-11: 2004	
Nr. / No.	Richtlinie / Directive		
2006/95/EG 2006/95/EC	Elektrische Betriebsmittel zur Verwendung innerhalb bestimmter Spannungsgrenzen - Niederspannungsrichtlinie - CE-Kennzeichnung : 95 Electrical equipment for use within certain voltage limits - Low Voltage Directive - Attachment of CE marking : 95		
EN/Norm/Standard	IEC/Norm/Standard		
EN 61010-1: 2001	IEC 61010-1: 2001		
Ort, Datum / Place, date:	Wohlen, 17. Februar 2009		
Unterschrift / signature:			
M. Ulrich Leiter Technik / Head of engineering	J. Brem Qualitätsmanager / Quality manager		

Declaration of conformity SINEAX A230s



**EG - KONFORMITÄTSERKLÄRUNG
EC DECLARATION OF CONFORMITY**



Dokument-Nr./ Document.No.: A230S_CE-konf.DOC

Hersteller/ Manufacturer: **Camille Bauer AG**
Switzerland

Anschrift / Address: **Aargauerstrasse 7**
CH-5610 Wohlen

Produktbezeichnung/ Product name: **Multifunktionales Leistungsmessgerät mit Netzanalyse**
Multifunctional Power Monitor with System Analysis

Typ / Type: **SINEAX A 230S**

Das bezeichnete Produkt stimmt mit den Vorschriften folgender Europäischer Richtlinien überein, nachgewiesen durch die Einhaltung folgender Normen:

The above mentioned product has been manufactured according to the regulations of the following European directives proven through compliance with the following standards:

Nr. / No.	Richtlinie / Directive
2004/108/EG	Elektromagnetische Verträglichkeit - EMV-Richtlinie
2004/108/EC	Electromagnetic compatibility - EMC directive

EMV / EMC	Fachgrundnorm / Generic Standard	Messverfahren / Measurement methods
Störaussendung / Emission	EN 61000-6-4 : 2007	EN 55011 : 2007+A2:2007
Störfestigkeit / Immunity	EN 61000-6-2 : 2005	IEC 61000-4-2: 1995+A1:1998+A2:2001 IEC 61000-4-3: 2006+A1:2007 IEC 61000-4-4: 2004 IEC 61000-4-5: 2005 IEC 61000-4-6: 2008 IEC 61000-4-8: 1993+A1:2000 IEC 61000-4-11: 2004

Nr. / No.	Richtlinie / Directive
2006/95/EG	Elektrische Betriebsmittel zur Verwendung innerhalb bestimmter Spannungsgrenzen – Niederspannungsrichtlinie – CE-Kennzeichnung : 95
2006/95/EC	Electrical equipment for use within certain voltage limits – Low Voltage Directive – Attachment of CE marking : 95

EN/Norm/Standard	IEC/Norm/Standard
EN 61010-1: 2001	IEC 61010-1: 2001

Ort, Datum / Place, date: Wohlen, 17. Februar 2009

Unterschrift / signature:

M. Ulrich
Leiter Technik / Head of engineering

J. Brem
Qualitätsmanager / Quality manager

Measurands display

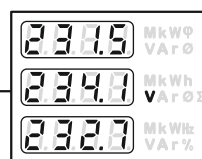

Back from any other display > 2s

> 2s

System configuration

Transformer ratios

Q definition

Output 1/Output 2

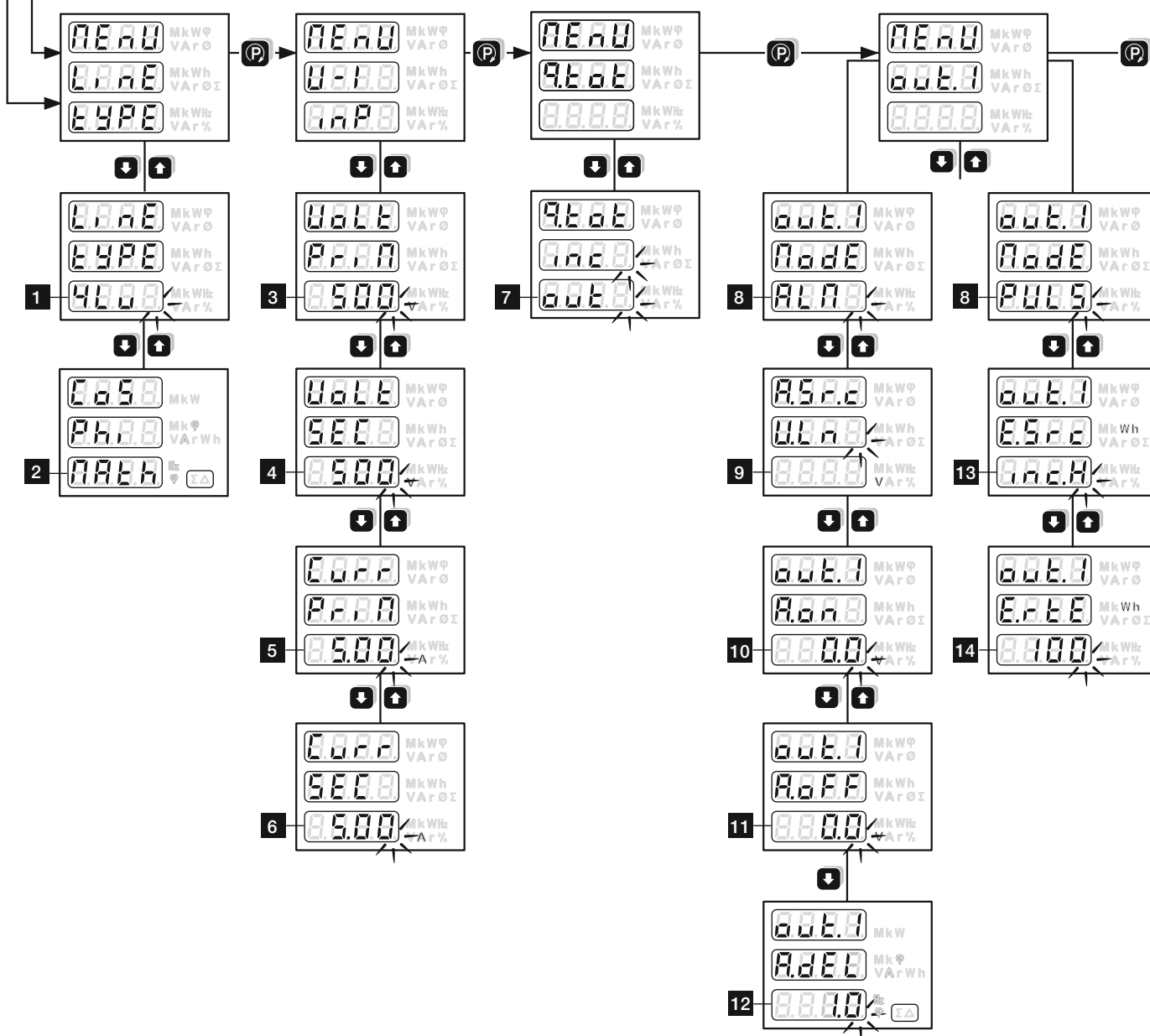

 configurable element

Display level

Menu level

Parameter level

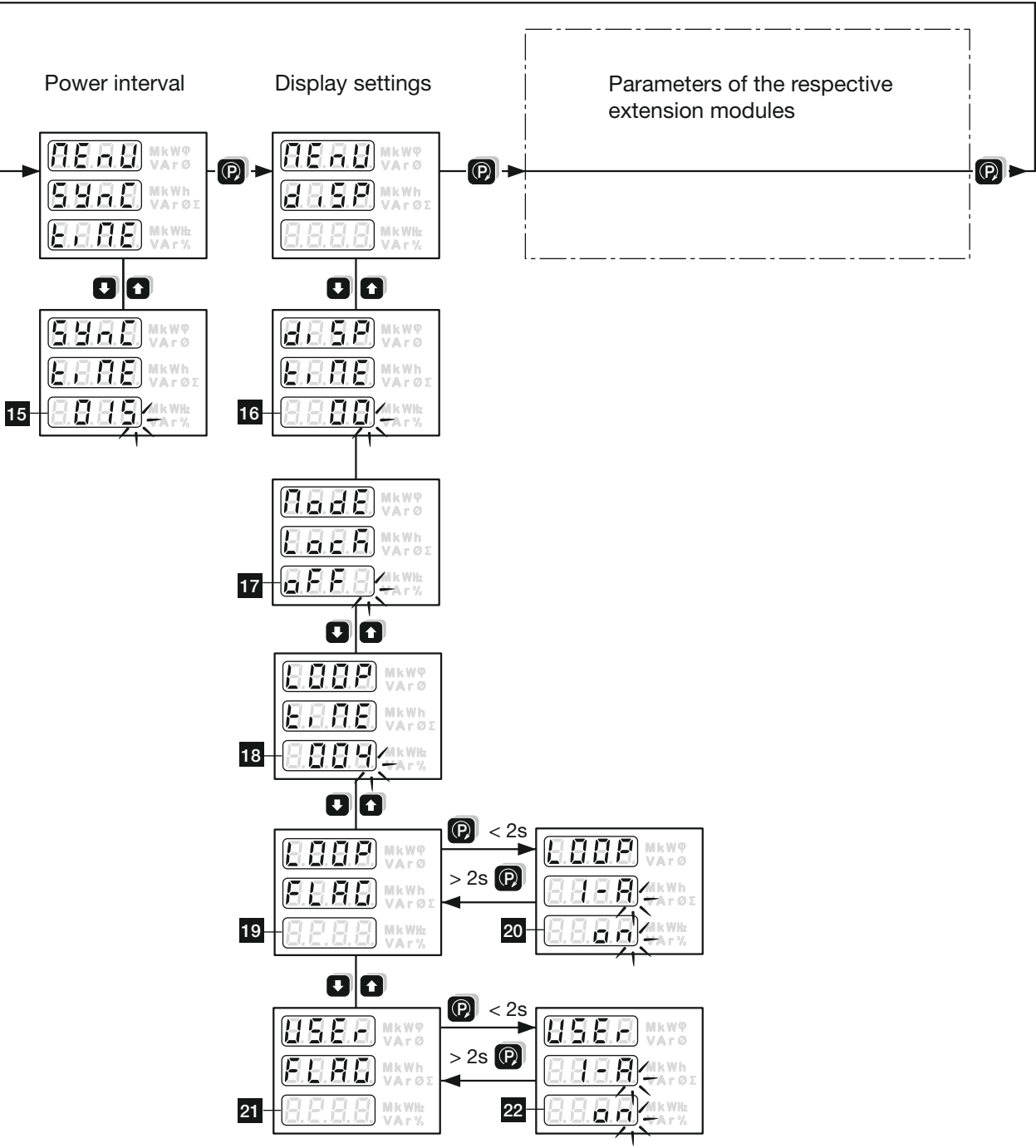

Dimensional drawing SINEAX A 230

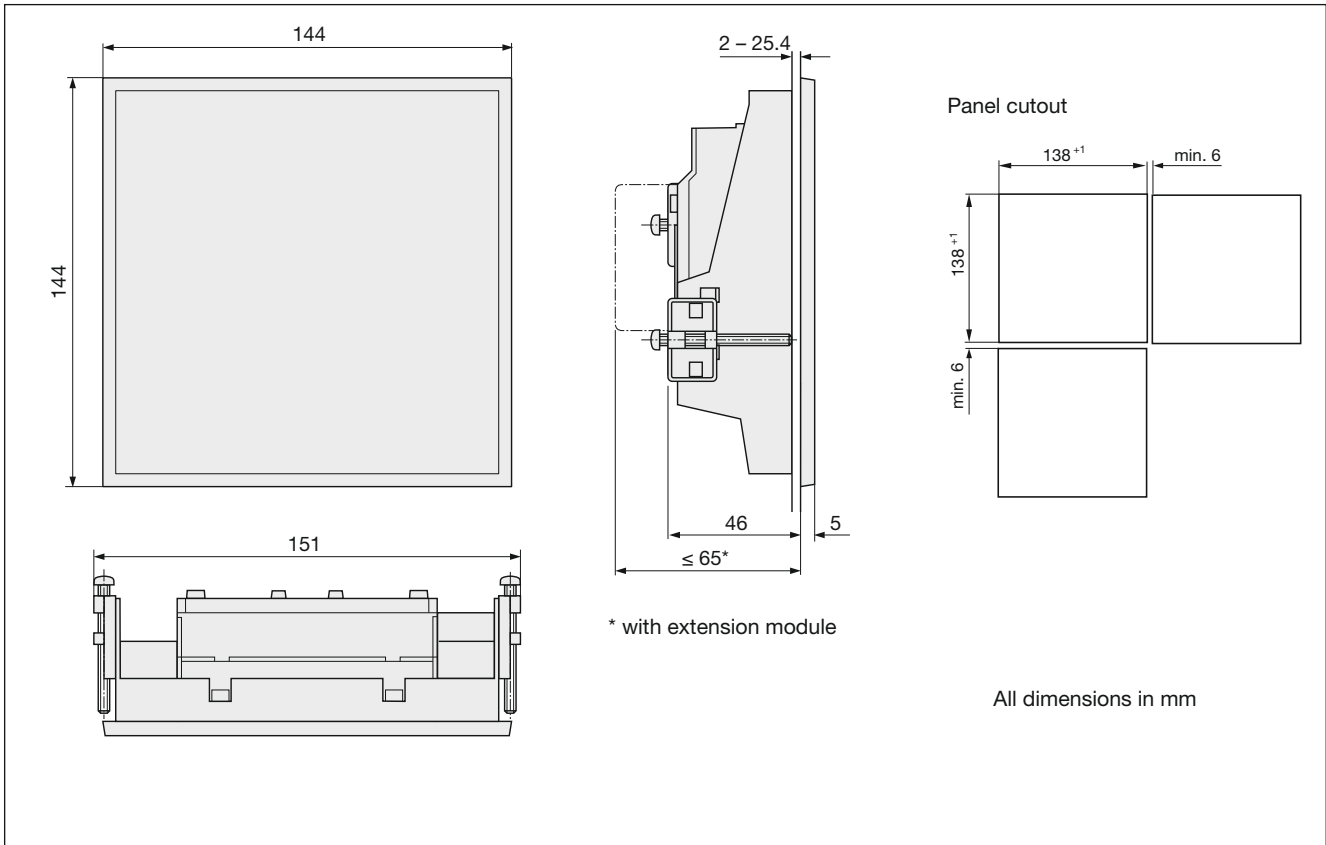

Dimensional drawing SINEAX A 230s

