

Input: 0-100 mV to 300 VDC, 0-1 mA to 0-5 ADC, 4-20 mA
Output: One 8 Amp DPDT Relay or Two 8 Amp SPDT Relays

- *Field Adjustable Setpoints*
- *Plug-In Design for Fast Installation*
- *Input LoopTracker® and Alarm Status LEDs*
- *Alarm Test, Optional Reset Button*
- *Sinking mA Input*

Applications

- *Process Limit Backup Alarm*
- *Tank Level Alarm*
- *Process Signal Over, Under, Out-of-Range Alarm*

DC Input Range

Factory configured, please specify input type and range
 System voltages should not exceed socket voltage rating
 Voltage: 0-100 mVDC to 0-300 VDC
 Current: 0-1 mA to 0-900 mA sinking
 5A option: 0-900 mA to 0-5 ADC

Input Impedance and Burden

Voltage: 250 kΩ minimum
 Current: 50 Ω typical
 Voltage burden: 1.25 VDC at 20 mA current input

Isolation and Input Protection

750 VAC_p or 750 VDC common mode protection
 Input isolated from power supply

LoopTracker

Variable brightness LED indicates input loop level and status

API 1000 G Relay Output

Two SPDT form C contact sets operating in unison as one DPDT contact set
 One setpoint, 12 turn potentiometer, 0-100% of span
 Factory configured alarm type
 Standard: HI alarm, non-latching, normal acting
 Options: LO alarm, latching, reverse acting

API 1020 G Relay Output

Two independent SPDT form C contact sets
 Two setpoints, two 12 turn potentiometers, 0-100% of span
 Factory configured alarm action
 Internal jumpers for HI/LO, LO/LO, HI/Hi, LO/Hi
 Standard: HI/LO alarm, non-latching, normal acting
 Options: LO/LO, HI/Hi, LO/Hi alarms, latching, reverse acting

Relay Contact Rating

8 A @ 240 VAC resistive load or 30 VDC resistive load
 5 A @ 240 VAC inductive load (cos φ = 0.4)
 3.5 A @ 30 VDC inductive load (L/R = 7ms)
 See graph on other side for relay load ratings

Caution: Do not exceed socket voltage rating
 Use an RC snubber for inductive loads

Deadband

Alarm trip/reset window is symmetrical about the setpoint
API 1000 G 1.0 to 100% of span, 12 turn potentiometer.
API 1020 G Fixed at 1% of span, standard
API 1020 G A Adjustable deadbands, 1.0 to 100% of span, 1 turn potentiometer for each setpoint

Output Test/Reset Button

Toggles relay(s) to opposite state when pressed
 Resets latching relay with HT option, available on 1000 G only

Response Time

70 milliseconds typical

Ambient Temperature Range and Stability

-10°C to +60°C operating ambient
 Better than 0.02% of span per °C stability

Housing and Sockets

IP 40, requires installation in panel or enclosure
 API 011 or API 011 FS socket
 Socket mounts to 35 mm DIN rail or can be surface mounted

Power

Standard: 115 VAC ±10%, 50/60 Hz, 2.5 W max.
 P option: 85-265 VAC 50/60 Hz, 60-300 VDC, 2.5 W typ.
 A230 option: 230 VAC ±10%, 50/60 Hz, 2.5 W max.
 D option: 9-30 VDC, 2.5 W typical

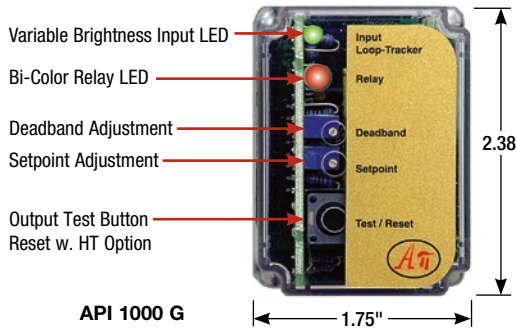

API 1000 G

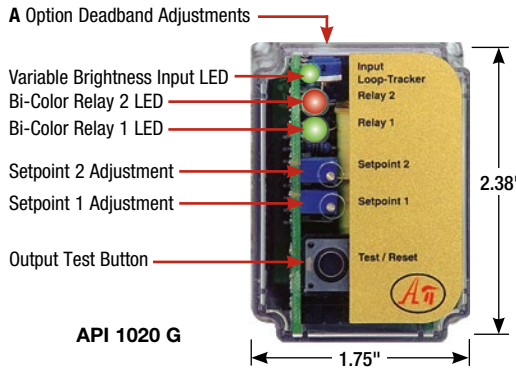

API 1020 G

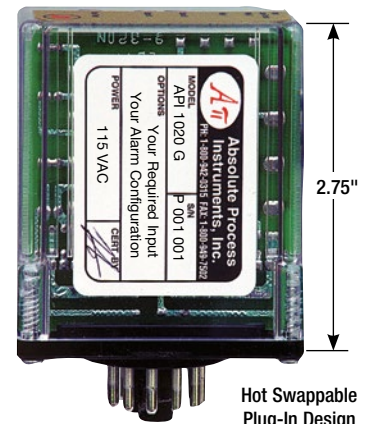

Hot Swappable Plug-In Design



Description

The API 1000 G and API 1020 G are factory configured for either a DC voltage or current input and provide alarm contact outputs. Heavy duty relay contacts allow the module to directly control high capacity loads.

The API 1000 G provides a single setpoint adjustment and DPDT relay contacts. The alarm output can be factory configured for HI or LO operation, non-latching or latching, normal or reverse acting. Top-accessible potentiometers are used to adjust the alarm setpoint and deadband.

The API 1020 G contains two independent setpoints with two SPDT relay contact outputs. The alarm output can be factory configured for HI/Hi, HI/LO, LO/Hi or LO/LO operation, normal acting or reverse acting. Top-accessible potentiometers are used to adjust each alarm setpoint. Deadband is fixed at 1% of span. Adjustable deadbands are optional.

LoopTracker and Alarm Status LEDs

API exclusive features include a LoopTracker LED that varies in intensity with changes in the process input signal.

A red/green bi-color alarm status LED (two on the API 1020 G) visually indicate alarm status. These LEDs provide a quick visual picture of your process at all times.

Output Test/Unlatch

API's exclusive functional test button can be used to verify the alarm and system operation. The output test button greatly aids in saving time during initial startup and/or troubleshooting.

The HT latching option provides the additional function of unlatching the alarm when the reset button is pressed. The alarm will reset if the alarm condition no longer exists.

Model	Input	Standard Alarm Configuration	Power
API 1000 G	Factory ranged, specify mV, V, or mA range Order 5A shunt option for 0-900 mA to 0-5 ADC inputs	Single setpoint one DPDT relay HI alarm, non-latching, normal acting	115 VAC
API 1000 G A230			230 VAC
API 1000 G P			85-265 VAC or 60-300 VDC
API 1000 G D			9-30 VDC
API 1020 G	Factory ranged, specify mV, V, or mA range Order 5A shunt option for 0-900 mA to 0-5 ADC inputs	2 setpoints, 2 SPDT relays HI/LO alarms, non-latching, normal acting	115 VAC
API 1020 G A230			230 VAC
API 1020 G P			85-265 VAC or 60-300 VDC
API 1020 G D			9-30 VDC

Options—add to end of model number

- L** 1000 G with LO trip. Alarm trips on decreasing signal.
- HT** 1000 G latching alarm with push button reset
- HP** 1000 G latching alarm with power-off reset. Module power must be turned off to reset alarms
- HH** 1020 G with HI/Hi trip. Alarms trip at their respective trip points on increasing signal.
- LL** 1020 G with LO/LO trip. Alarms trip at their respective trip points on decreasing signal.
- A** 1020 G with adjustable deadbands.
- R** Reverse-acting alarms. Relay coils energized in an alarm condition. No alarm condition with module power off.
- 5A** Shunt for 0-900 mA to 0-5 ADC inputs. Includes API 011 socket and 0.1 Ω 25W 1% shunt resistor.
- U** Conformal coating for moisture resistance

Accessories—order as a separate line item

- API 011** 11-pin socket, DIN rail or surface mount
- API 011 FS** 11-pin finger safe socket, DIN rail or surface mount
- API CLP1** Module hold-down spring for high vibration or mobile applications



Precautions

WARNING! All wiring must be performed by a qualified electrician or instrumentation engineer. See diagram for terminal designations and wiring examples. Consult factory for assistance.

WARNING! Avoid shock hazards! Turn signal input, output, and power off before connecting or disconnecting wiring, or removing or installing module.

Précautions

ATTENTION! Tout le câblage doit être effectué par un électricien ou ingénieur en instrumentation qualifié. Voir le diagramme pour désignations des bornes et des exemples de câblage. Consulter l'usine pour assistance.

ATTENTION! Éviter les risques de choc! Fermez le signal d'entrée, le signal de sortie et l'alimentation électrique avant de connecter ou de déconnecter le câblage, ou de retirer ou d'installer le module.

API maintains a constant effort to upgrade and improve its products. Specifications are subject to change without notice. See api-usa.com for latest product information. Consult factory for your specific requirements.

WARNING! This product can expose you to chemicals including lead and nickel, which are known to the State of California to cause cancer or birth defects or other reproductive harm. For more information go to www.P65Warnings.ca.gov

Alarm Configuration

API 1000 G relay operation is factory configured. The default configuration is HI alarm normal acting. See model/serial number label for non-standard relay configuration options.

API 1020 G relay operation is factory configured, but internal jumpers can be used to modify the alarm type as follows.

1. Unplug the module from the socket.
2. Remove the 4 screws from the module bottom and remove the plastic case.
3. Unplug the circuit board with the test button from the base.
4. Note location of jumper block at top left of circuit board next to test button. See diagram at right.
5. Place jumpers as indicated for desired alarm operation. The standard HI/LO setting is with one jumper across the two top pins or with no jumper at all. Never place a jumper across the two bottom pins!
6. Replace board, cover, and screws.

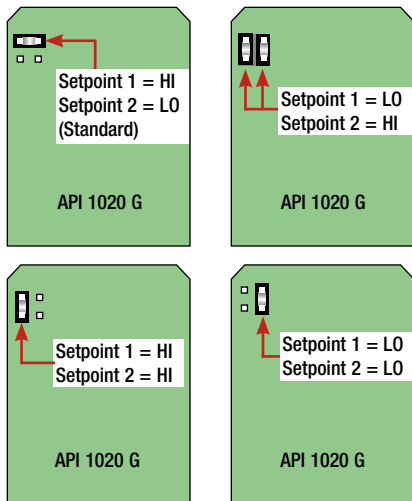

API 1020 G Internal Alarm Configuration Jumpers

Socket and Mounting

The module installation requires a protective panel or enclosure. Use API 011 or finger-safe API 011 FS socket. See specifications for maximum allowable socket voltages. Note that some relay sockets may have lower voltage ratings. The socket clips to a standard 35 mm DIN rail or can be attached to a flat surface using the two mounting holes.

Input

The input range is factory configured and calibrated, and does not require adjustment. See the model/serial number label for input type, range, and options. See wiring diagram for connections. Polarity must be observed. For a mA input the module does not provide power to the input loop.

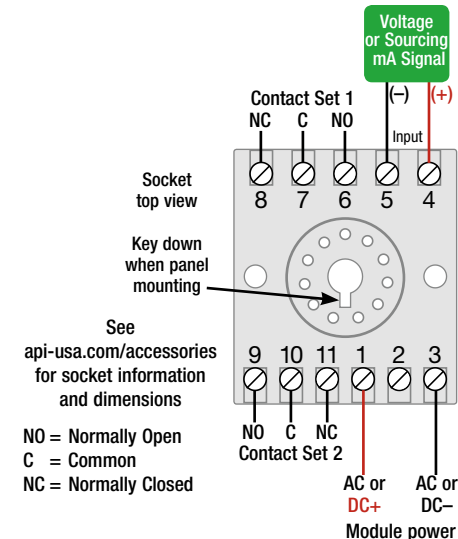

Relay Output

See wiring diagram for connections. The module does not provide power to the relay contacts.

Inductive loads (motors, solenoids, contactors, etc.) will greatly shorten relay contact life unless an appropriate RC snubber is installed.

Module Power

Check model/serial number label for module operating voltage to make sure it matches available power.

When using DC power, polarity must be observed. The positive (+) must be wired to terminal 1 and negative (-) must be wired to terminal 3.

Setpoint

This multi-turn potentiometer (one for each setpoint on the API 1020 G) allows the operator to adjust the level at which the alarm is activated. This control is adjustable from 0 to 100% of the input range.

Deadband

The API 1000 G deadband potentiometer allows the alarm trip/reset window to be adjusted symmetrically about the setpoint from 1 to 100% of the span.

The deadband is fixed at 1% of span on the API 1020 G. The API 1020 G A with adjustable deadband option allows deadbands to be adjusted symmetrically about each setpoint from 1 to 100% of the span.

Deadband allows the operator to fine tune the point at which the alarm trips and resets. The deadband is typically used to prevent chattering of the relays or false trips when the process signal is unstable or changes rapidly.

Adjustments

To calibrate the alarm section, set the deadband control to the minimum (counterclockwise). The deadband will be 1.0% of input span in this case.

Set the signal source to a reference that represents the desired trip point.

Adjust the setpoint control to the point at which the relay changes state from a non-alarm to an alarm condition.

If a larger amount of deadband is desired turn the deadband potentiometer clockwise. The deadband is symmetrical about the setpoint; both transition points will change as deadband is increased.

Alternately set the setpoint and deadband until the desired trip/reset points are set.

Output Test Function

The functional test button toggles the alarm status independent of the input when depressed. It verifies the alarm and system operation. When released, the relays will return to their prior states. This can be used as a diagnostic aid during initial start-up or troubleshooting.

The API 1000 G with the HT latching alarm option, the test button provides the additional function of unlatching the alarm relays provide the alarm condition no longer exists.

Operation

The green LoopTracker® input LED provides a visual indication that a signal is being sensed by the input circuitry of the module. It also indicates the input signal strength by changing in intensity as the process changes from minimum to maximum.

If the LED fails to illuminate, or fails to change in intensity as the process changes, check the module power or signal input wiring. Note that it may be difficult to see the LEDs under bright lighting conditions.

The bi-color alarm LED provides a visual indication of the alarm status. In all configurations, a green LED indicates a non-alarm condition and a red LED indicates an alarm condition.

NOTE: Although the API 1000 G has a pair of relays, these relays will energize and de-energize in unison.

The API 1020 G will accommodate independent relay operations.

High Alarm (Default, H, or HH)

The alarm relay changes state when the input exceeds the deadband trip point. The relay resets when the input drops below the deadband reset point unless the module has a latching relay option. For a high alarm, the trip point is above the reset point.

Low Alarm (L or LL)

The alarm relay changes state when the input goes below the deadband trip point. The relay resets when the input exceeds the deadband reset point unless the module has a latching relay option. For a low alarm, the trip point is below the reset point.

HT Option (API 1000 G Only)

The module has a latching alarm with a push button reset. The Test button or powering the module off can be used to reset the alarm provided the alarm condition no longer exists.

HP Option (API 1000 G Only)

The module has a latching alarm with a power-off reset. Module power must be turned off to reset alarms. The alarm will reset provided the alarm condition no longer exists.

Normal Acting Alarms (Standard)

Normal acting alarms energize the relay coils in a non-alarm condition and de-energize them in an alarm condition. This will create an alarm condition if the module loses power.

Reverse Acting Alarms (R Option)

Reverse-acting alarms energize the relay coils in an alarm condition and de-energize them in a non-alarm condition. There is no alarm condition with module power off.

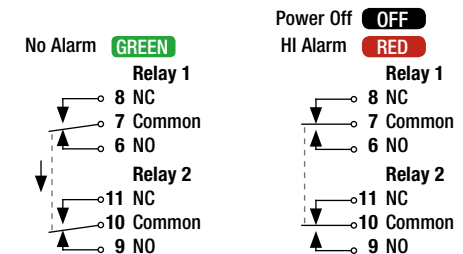

API 1000 G Alarm States with Normal Action HI Alarm

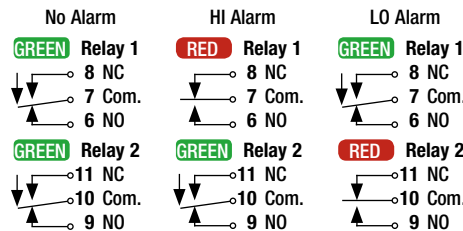

API 1020 G Alarm States with Normal Action HI/LO Alarms

