

Input: RTD or Custom Sensor
Output: 0-1 V to 0-10 V, ±5 V, ±10 V, 0-2 mA to 4-20 mA, Reverse Acting Optional

[Quick Link: api-usa.com/apd4151](http://api-usa.com/apd4151)

- One Model Covers All Common RTD Sensors
- Zero and Span for Output
- Full 1200 V Isolation
- Input LoopTracker® LED
- Output Test Function
- Built-In Loop Power Supply for Sink/Source Output

Applications

- Convert/Isolate RTD Sensors for PLC Input, Control and/or Validation
- Interface RTD Sensors with Panel Meters, PLCs, Recorders, Data Acq., DCS, & SCADA Systems

Input Types, Field Selectable

RTDs: 2, 3, or 4 wire, 10 Ω to 8000 Ω RTDs
 4 wire with or without current rotation
 Cu-10, Cu-100, Ni-100, Ni-120,
 Ni-Fe-500, Ni-Fe-1000, Ni-Fe-2000,
 Pt-10, Pt-25, Pt-50, Pt-100, Pt-200,
 Pt-470, Pt-500, Pt-1000

Custom: Provide sensor specifications, temperature curve data, and temperature range

LoopTracker

Variable brightness green LED indicates input level and status

Status LED

Yellow LED for setup and operational status

DC Output Ranges, Field Selectable

Voltage: 0-1 V, 0-2 V, 0-4 V,
 0-5 V, 1-5 V, 0-8 V,
 0-10 V, 2-10 V,
 ±5 VDC, ±10 VDC

Current: 0-2 mA, 0-4 mA, 0-8 mA,
 0-10 mA, 2-10 mA,
 0-16 mA, 0-20 mA,
 4-20 mA
 20 V compliance, 1000 Ω at 20 mA

Reverse Acting Output, Factory Set

R option: Reverse acting output
 increasing input = decreasing output signal

Reverse acting models cannot be converted to direct acting

Output Calibration

Zero and span set by using up/down buttons, ±10% range

Output Ripple and Noise

Less than ±0.2% of span

Output Loop Power Supply

20 VDC nom., regulated, 25 mA DC, <10 mVrms max. ripple
 May be selectively wired for sinking or sourcing mA output

Output Test

Front push button switch enables/disables test level output
 Adjustable 0-100% of span via up/down buttons

Accuracy and Resolution

±0.1°C accuracy, 0.001°C resolution, 18 bit

Response Time

300 milliseconds typical

Isolation

Full 3-way isolation: input, output, power, 1200 Vrms min.
 600 VACp or 600 VDC common mode protection
 75 dB minimum common mode rejection
 Simultaneous 50 Hz and 60 Hz rejection

Ambient Temperature Range and Stability

-10°C to +60°C operating ambient
 Better than 0.02% of span per °C

Housing and Connectors

IP 40, requires vertical installation on a 35 mm DIN rail inside a panel or enclosure

For use in Pollution Degree 2 Environment

Four 4-terminal removable connectors, 14 AWG max. wire size

Power

85-265 VAC, 50/60 Hz or 60-300 VDC, 3 W maximum
 D versions: 9-30 VDC or 10-32 VAC 50/60 Hz, 3 W maximum



Sink or Source
 mA Output

Setup and Status
 LED

Adjustable Output
 Test Function

Zero and Span for
 Output

Input LoopTracker
 LED

Universal RTD Input



[Applications Link](http://api-usa.com/apps)
api-usa.com/apps

Free Factory
 I/O Setup!

Dimensions

Height includes connectors
 0.89" W x 4.62" H x 4.81" D (22.5 x 117 x 122 mm)

Description

The APD 4151 accepts an RTD temperature input and provides an optically isolated and linearized DC voltage or current output.

The RTD type, temperature range and output range are field configurable. The RTD type is set with switches and its range is configured using front buttons, a multimeter and an input simulator. This provides a versatile solution that works with all commonly available RTD sensors.

Microprocessor-based linearization uses 41 to 55 segments or up to a 14th order polynomial depending on the sensor type. The input is sampled, digitally converted to a linearized temperature signal and then passed through an optocoupler to the output stage.

Full 3-way isolation (input, output, power) make this module useful for ground loop elimination, common mode signal rejection, and noise pickup reduction.

The low noise 18 bit analog output is isolated and can be set up for common voltage and milliamp output types.

How to Order

Models are field rangeable. For free setup specify the following.

RTD: Model/type, resistance, curve, no. of wires
 If 4 wire: with or without current rotation
 Custom: Complete sensor data over temperature range
 Temperature: Range in °F or °C
 Output: Range and type (mV, V, mA)
 Default: Pt100, 385 curve, 4 wire, 100 to 500°C,
 4-20 mA output

Model	Description	Power
APD 4151	RTD input to DC output isolated transmitter	85-265 VAC, 50/60 Hz or 60-300 VDC
APD 4151 D		9-30 VDC or 10-32 VAC



Output Sink/Source Versatility

Standard on the APD 4151 is a 20 VDC loop excitation supply for the milliamp output. The output can be selectively wired for sinking or sourcing allowing use with a powered or unpowered milliamp device.

LoopTracker

An API exclusive feature includes a green LoopTracker LED that varies in intensity with changes in the process input signal.

It provides a quick visual picture of your process input at all times and can greatly aid in saving time during initial startup and troubleshooting.

Output Test

An API exclusive feature includes an output test switch to provide a fixed output (independent of the input) when pressed. The output test greatly aids in saving time during initial startup and/or troubleshooting.

The test output level is adjustable from 0 to 100% of the output span.

Options and Accessory

Options—add to end of model number

- NC5 5 point NIST traceable calibration certificate
- NC11 11 point NIST traceable calibration certificate
- U Conformal coating for moisture resistance
- R Reverse acting output

Accessory—order as separate line item

API BP4 Spare removable 4 terminal plug, black

Note: An appropriate simulator and a multimeter are required for setup. We can set up the I/O ranges at no extra charge.

Precautions

WARNING! All wiring must be performed by a qualified electrician or instrumentation engineer. See diagram for terminal designations and wiring examples. Consult factory for assistance.

WARNING! Avoid shock hazards! Turn signal input, output, and power off before connecting or disconnecting wiring, or removing or installing module.

Précautions

ATTENTION! Tout le câblage doit être effectué par un électricien ou ingénieur en instrumentation qualifié. Voir le diagramme pour désignations des bornes et des exemples de câblage. Consulter l'usine pour assistance.

ATTENTION! Éviter les risques de choc! Fermez le signal d'entrée, le signal de sortie et l'alimentation électrique avant de connecter ou de déconnecter le câblage, ou de retirer ou d'installer le module.

Range Selection

Select ranges before installation. A 4 wire RTD with current rotation input requires changing an internal jumper. Use the tables on the next pages to select the I/O ranges and jumper settings. The module side label lists output ranges. Ranges can also be found at api-usa.com/4151

Check the model/serial number label for module power, options, or custom range information. A custom range uses switch settings described in the Custom Range Table.

Models with **R** reverse acting output use the same switch settings, except the output range is reversed (4-20 mA is 20-4 mA).

1. Set switches A, B, and C from the table to set input type and range.
2. Set switches D and E from the table to set the output range and set switch E: V for voltage or I for current output.

For output ranges that fall between the listed ranges use the next highest setting. The output can be trimmed using the zero and span buttons.

Electrical Connections

See wiring diagrams at right. A multimeter and an RTD simulator are required for setup. Observe polarity. If the output does not function, check wiring and polarity.

The power supplies are fuse protected and the unit may be returned to API for fuse replacement.

Input

The RTD sensor input is connected as shown in the wiring diagrams at right. If a custom input was specified, see the model/serial number label for sensor type, temperature range and options.

Output

For milliamp ranges, determine if your device provides power to the current loop or if the loop must be powered by the APD module. Typical voltage may be 9-24 VDC at your device's terminals if it provides power to the loop.

Module Power

Check model/serial number label for module operating voltage to make sure it matches available power.

When using DC power, either polarity is acceptable, but for consistency with similar API products, positive (+) can be wired to terminal 13 and negative (-) can be wired to terminal 16.

Range Calibration

1. Connect a multimeter to the output terminals 2 - 3, or 3 - 4 depending on output type. See wiring diagram at right.
2. Connect an RTD simulator to the input of the module.
3. Connect power to the unit (terminals 13, 14, and 16) and apply power to the module.
4. Wait until the yellow Status LED starts blinking once per second.

Low End Input Calibration

5. Use the simulator to apply the low end of the input signal.
6. Push the Set button to store the low end input value.
7. The Status LED will turn on to indicate the reading was saved.
8. Use the Up and Down buttons to adjust the output to the desired low output reading (i.e. 4 mA for a 4-20 mA output).
9. Press and release the Set button to store the low output.

High End Input Calibration

10. Wait until the Status LED blinks once per second.
11. Use the simulator to apply the high end of the input signal.
12. Push the Set button to store the high end input value.
13. The Status LED will turn on to indicate the reading was saved.
14. Use the Up and Down buttons to adjust the output to the desired high output reading (i.e. 20 mA for a 4-20 mA output).
15. Press and release the Set button to store the high output.

Blinking Yellow LED Setup Error Codes

If an error occurred or invalid selection was made, the yellow Status LED blinks an error code. Check switches A, B, C, and input wiring.

- 2 1 Invalid sensor selected 
- 2 3 Invalid RTD selected 
- 2 7 Invalid input setting (Zero greater than Span) 

Output Test Level Adjustment

16. Wait until the Status LED turns on and stays on.
17. Using the Up and Down buttons adjust the test output for the desired level (i.e. 12 mA for a 4-20 mA output).
18. Press and release the Set button to store the test output.
19. Wait until the Status LED starts blinks once per second.
20. To change any value, turn off the power and repeat steps 1 to 19.

Saving Setup

21. Press and release the Set button to store the settings and lock them into memory. The Status LED will be on during this process.
22. Once the Status LED turns off, setup and configuration is complete. Turn off power to the unit and remove the simulator and multimeter.

Changing I/O Setup

To reset the unit back to factory default without changing any input switch settings press and hold the Set button while the module is being powered up.

If using a new input switch setting, the unit will automatically start in setup mode to allow you to calibrate and store your new configuration.

Mounting to a DIN Rail

Install module vertically on a 35 mm DIN rail in a protective enclosure away from heat sources. Do not block air flow.

1. Tilt front of module downward and clip the lower mount with spring clips to the bottom edge of DIN rail.
2. Push front of module upward until upper mount snaps into place.



Removal

Avoid shock hazards! Turn signal input, output, and power off before removing module.

1. Push up on bottom back of module.
2. Tilt the front of module downward to release upper mount from top edge of DIN rail.
3. The module can now be removed from the DIN rail.

Output Test Function

When the Test button is pressed it will drive the output with a known good signal that can be used as a diagnostic aid during initial start-up or troubleshooting. When pressed again, the output will return to normal. The button allows hands-free operation of the Test Mode.

The Test level can be adjusted by using the Up and Down buttons.

The level can be set by pressing the Set button, or it can default back to the setup value by not pressing the Set button.

Operation

The APD 4151 accepts an RTD input and provides a linearized and optically isolated DC voltage or current output.

The green LoopTracker® input LED provides a visual indication that a signal is being sensed by the input circuitry of the module. It also indicates the input signal strength by changing in intensity as the process changes from minimum to maximum.





If the LED fails to illuminate, or fails to change in intensity as the process changes, check the module power or signal input wiring. Note that it may be difficult to see the LEDs under bright lighting conditions.

The yellow status LED provides a visual indication of operational modes.

- Normal operation: Off
- Push-to-Test mode: Steadily on
- User setup mode: Blinking

Blinking Yellow LED Operational Error Codes

If an error occurs during operation, the yellow Status LED blinks an error code. Check sensor, wiring, or consult factory.

- 1 1 Analog-digital converter out-of-range 
- 1 2 Sensor under range 
- 1 3 Sensor over range 
- 1 6 Hard ADC out-of-range 
- 1 7 Sensor hard fault, open circuit, hard ADC fault 



Do not connect anything to unused terminals

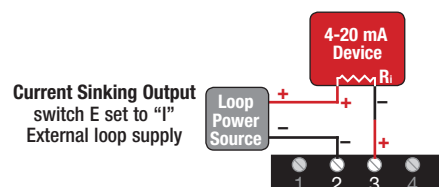
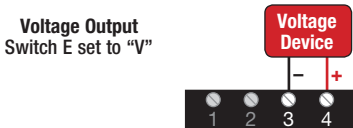

Do Not Connect to Unused Terminals 1, 5, 6, 7, 8

Yellow status LED

Setup: blinks once per second

Off: normal operation

2 digit code: error code

Green LoopTracker LED brightness varies with input level

To maintain full isolation and avoid malfunctions, do not connect power supplies in common with input, output or unit power.

Do not connect any devices to unused terminals.

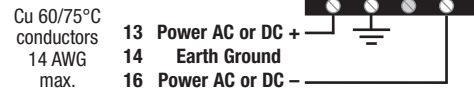
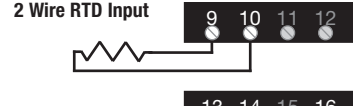
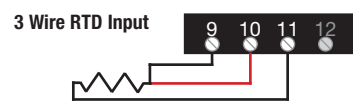
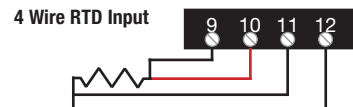
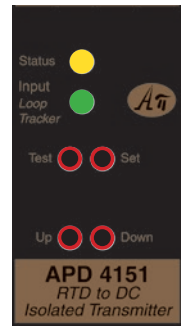

Range Table: 2 Wire and 3 Wire RTDs

For models with "R" option, output ranges are reversed

2 Wire RTD	Output	±10 V	0-10 V	±5 V	2-10 V	0-8 V	0-5 V	1-5 V	0-4 V	0-2 V	0-1 V	0-20 mA	4-20 mA	0-16 mA	0-10 mA	2-10 mA	0-8 mA	0-4 mA	0-2 mA	
	Switches	ABCDE	ABCDE	ABCDE	ABCDE	ABCDE	ABCDE	ABCDE	ABCDE	ABCDE	ABCDE	ABCDE	ABCDE	ABCDE	ABCDE	ABCDE	ABCDE	ABCDE	ABCDE	ABCDE
Type	Curve																			
Cu-10	0.00427	2185V	2183V	2184V	2187V	2182V	2189V	2186V	2181V	2188V	2180V	2183I	2187I	2182I	2189I	2186I	2181I	2188I	2180I	
Cu-100	0.00427	2285V	2283V	2284V	2287V	2282V	2289V	2286V	2281V	2288V	2280V	2283I	2287I	2282I	2289I	2286I	2281I	2288I	2280I	
Ni-100	0.00618	2385V	2383V	2384V	2387V	2382V	2389V	2386V	2381V	2388V	2380V	2383I	2387I	2382I	2389I	2386I	2381I	2388I	2380I	
Ni-120	0.00672	2485V	2483V	2484V	2487V	2482V	2489V	2486V	2481V	2488V	2480V	2483I	2487I	2482I	2489I	2486I	2481I	2488I	2480I	
Ni-Fe-500	0.00518	2585V	2583V	2584V	2587V	2582V	2589V	2586V	2581V	2588V	2580V	2583I	2587I	2582I	2589I	2586I	2581I	2588I	2580I	
Ni-Fe-1000	0.00527	2685V	2683V	2684V	2687V	2682V	2689V	2686V	2681V	2688V	2680V	2683I	2687I	2682I	2689I	2686I	2681I	2688I	2680I	
Ni-Fe-2000	0.00527	2785V	2783V	2784V	2787V	2782V	2789V	2786V	2781V	2788V	2780V	2783I	2787I	2782I	2789I	2786I	2781I	2788I	2780I	
Pt-10	0.00385	28A5V	28A3V	28A4V	28A7V	28A2V	28A9V	28A6V	28A1V	28A8V	28A0V	28A3I	28A7I	28A2I	28A9I	28A6I	28A1I	28A8I	28A0I	
Pt-10	0.003911	28B5V	28B3V	28B4V	28B7V	28B2V	28B9V	28B6V	28B1V	28B8V	28B0V	28B3I	28B7I	28B2I	28B9I	28B6I	28B1I	28B8I	28B0I	
Pt-10	0.003916	28C5V	28C3V	28C4V	28C7V	28C2V	28C9V	28C6V	28C1V	28C8V	28C0V	28C3I	28C7I	28C2I	28C9I	28C6I	28C1I	28C8I	28C0I	
Pt-10	0.003926	28D5V	28D3V	28D4V	28D7V	28D2V	28D9V	28D6V	28D1V	28D8V	28D0V	28D3I	28D7I	28D2I	28D9I	28D6I	28D1I	28D8I	28D0I	
Pt-25	0.003926	29D5V	29D3V	29D4V	29D7V	29D2V	29D9V	29D6V	29D1V	29D8V	29D0V	29D3I	29D7I	29D2I	29D9I	29D6I	29D1I	29D8I	29D0I	
Pt-50	0.00385	2AA5V	2AA3V	2AA4V	2AA7V	2AA2V	2AA9V	2AA6V	2AA1V	2AA8V	2AA0V	2AA3I	2AA7I	2AA2I	2AA9I	2AA6I	2AA1I	2AA8I	2AA0I	
Pt-50	0.003911	2AB5V	2AB3V	2AB4V	2AB7V	2AB2V	2AB9V	2AB6V	2AB1V	2AB8V	2AB0V	2AB3I	2AB7I	2AB2I	2AB9I	2AB6I	2AB1I	2AB8I	2AB0I	
Pt-50	0.003916	2AC5V	2AC3V	2AC4V	2AC7V	2AC2V	2AC9V	2AC6V	2AC1V	2AC8V	2AC0V	2AC3I	2AC7I	2AC2I	2AC9I	2AC6I	2AC1I	2AC8I	2AC0I	
Pt-50	0.003926	2AD5V	2AD3V	2AD4V	2AD7V	2AD2V	2AD9V	2AD6V	2AD1V	2AD8V	2AD0V	2AD3I	2AD7I	2AD2I	2AD9I	2AD6I	2AD1I	2AD8I	2AD0I	
Pt-100	0.00385	2BA5V	2BA3V	2BA4V	2BA7V	2BA2V	2BA9V	2BA6V	2BA1V	2BA8V	2BA0V	2BA3I	2BA7I	2BA2I	2BA9I	2BA6I	2BA1I	2BA8I	2BA0I	
Pt-100	0.003911	2BB5V	2BB3V	2BB4V	2BB7V	2BB2V	2BB9V	2BB6V	2BB1V	2BB8V	2BB0V	2BB3I	2BB7I	2BB2I	2BB9I	2BB6I	2BB1I	2BB8I	2BB0I	
Pt-100	0.003916	2BC5V	2BC3V	2BC4V	2BC7V	2BC2V	2BC9V	2BC6V	2BC1V	2BC8V	2BC0V	2BC3I	2BC7I	2BC2I	2BC9I	2BC6I	2BC1I	2BC8I	2BC0I	
Pt-100	0.003926	2BD5V	2BD3V	2BD4V	2BD7V	2BD2V	2BD9V	2BD6V	2BD1V	2BD8V	2BD0V	2BD3I	2BD7I	2BD2I	2BD9I	2BD6I	2BD1I	2BD8I	2BD0I	
Pt-200	0.00385	2CA5V	2CA3V	2CA4V	2CA7V	2CA2V	2CA9V	2CA6V	2CA1V	2CA8V	2CA0V	2CA3I	2CA7I	2CA2I	2CA9I	2CA6I	2CA1I	2CA8I	2CA0I	
Pt-200	0.003911	2CB5V	2CB3V	2CB4V	2CB7V	2CB2V	2CB9V	2CB6V	2CB1V	2CB8V	2CB0V	2CB3I	2CB7I	2CB2I	2CB9I	2CB6I	2CB1I	2CB8I	2CB0I	
Pt-200	0.003916	2CC5V	2CC3V	2CC4V	2CC7V	2CC2V	2CC9V	2CC6V	2CC1V	2CC8V	2CC0V	2CC3I	2CC7I	2CC2I	2CC9I	2CC6I	2CC1I	2CC8I	2CC0I	
Pt-200	0.003926	2CD5V	2CD3V	2CD4V	2CD7V	2CD2V	2CD9V	2CD6V	2CD1V	2CD8V	2CD0V	2CD3I	2CD7I	2CD2I	2CD9I	2CD6I	2CD1I	2CD8I	2CD0I	
Pt-470	0.003926	2DD5V	2DD3V	2DD4V	2DD7V	2DD2V	2DD9V	2DD6V	2DD1V	2DD8V	2DD0V	2DD3I	2DD7I	2DD2I	2DD9I	2DD6I	2DD1I	2DD8I	2DD0I	
Pt-500	0.00385	2EA5V	2EA3V	2EA4V	2EA7V	2EA2V	2EA9V	2EA6V	2EA1V	2EA8V	2EA0V	2EA3I	2EA7I	2EA2I	2EA9I	2EA6I	2EA1I	2EA8I	2EA0I	
Pt-500	0.003911	2EB5V	2EB3V	2EB4V	2EB7V	2EB2V	2EB9V	2EB6V	2EB1V	2EB8V	2EB0V	2EB3I	2EB7I	2EB2I	2EB9I	2EB6I	2EB1I	2EB8I	2EB0I	
Pt-500	0.003916	2EC5V	2EC3V	2EC4V	2EC7V	2EC2V	2EC9V	2EC6V	2EC1V	2EC8V	2EC0V	2EC3I	2EC7I	2EC2I	2EC9I	2EC6I	2EC1I	2EC8I	2EC0I	
Pt-500	0.003926	2ED5V	2ED3V	2ED4V	2ED7V	2ED2V	2ED9V	2ED6V	2ED1V	2ED8V	2ED0V	2ED3I	2ED7I	2ED2I	2ED9I	2ED6I	2ED1I	2ED8I	2ED0I	
Pt-1000	0.00375	2F95V	2F93V	2F94V	2F97V	2F92V	2F99V	2F96V	2F91V	2F98V	2F90V	2F93I	2F97I	2F92I	2F99I	2F96I	2F91I	2F98I	2F90I	
Pt-1000	0.00385	2FA5V	2FA3V	2FA4V	2FA7V	2FA2V	2FA9V	2FA6V	2FA1V	2FA8V	2FA0V	2FA3I	2FA7I	2FA2I	2FA9I	2FA6I	2FA1I	2FA8I	2FA0I	
Pt-1000	0.003911	2FB5V	2FB3V	2FB4V	2FB7V	2FB2V	2FB9V	2FB6V	2FB1V	2FB8V	2FB0V	2FB3I	2FB7I	2FB2I	2FB9I	2FB6I	2FB1I	2FB8I	2FB0I	
Pt-1000	0.003916	2FC5V	2FC3V	2FC4V	2FC7V	2FC2V	2FC9V	2FC6V	2FC1V	2FC8V	2FC0V	2FC3I	2FC7I	2FC2I	2FC9I	2FC6I	2FC1I	2FC8I	2FC0I	
Pt-1000	0.003926	2FD5V	2FD3V	2FD4V	2FD7V	2FD2V	2FD9V	2FD6V	2FD1V	2FD8V	2FD0V	2FD3I	2FD7I	2FD2I	2FD9I	2FD6I	2FD1I	2FD8I	2FD0I	
3 Wire RTD	Output	±10 V	0-10 V	±5 V	2-10 V	0-8 V	0-5 V	1-5 V	0-4 V	0-2 V	0-1 V	0-20 mA	4-20 mA	0-16 mA	0-10 mA	2-10 mA	0-8 mA	0-4 mA	0-2 mA	
	Switches	ABCDE	ABCDE	ABCDE	ABCDE	ABCDE	ABCDE	ABCDE	ABCDE	ABCDE	ABCDE	ABCDE	ABCDE	ABCDE	ABCDE	ABCDE	ABCDE	ABCDE	ABCDE	ABCDE
Type	Curve																			
Cu-10	0.00427	3185V	3183V	3184V	3187V	3182V	3189V	3186V	3181V	3188V	3180V	3183I	3187I	3182I	3189I	3186I	3181I	3188I	3180I	
Cu-100	0.00427	3285V	3283V	3284V	3287V	3282V	3289V	3286V	3281V	3288V	3280V	3283I	3287I	3282I	3289I	3286I	3281I	3288I	3280I	
Ni-100	0.00618	3385V	3383V	3384V	3387V	3382V	3389V	3386V	3381V	3388V	3380V	3383I	3387I	3382I	3389I	3386I	3381I	3388I	3380I	
Ni-120	0.00672	3485V	3483V	3484V	3487V	3482V	3489V	3486V	3481V	3488V	3480V	3483I	3487I	3482I	3489I	3486I	3481I	3488I	3480I	
Ni-Fe-500	0.00518	3585V	3583V	3584V	3587V	3582V	3589V	3586V	3581V	3588V	3580V	3583I	3587I	3582I	3589I	3586I	3581I	3588I	3580I	
Ni-Fe-1000	0.00527	3685V	3683V	3684V	3687V	3682V	3689V	3686V	3681V	3688V	3680V	3683I	3687I	3682I	3689I	3686I	3681I	3688I	3680I	
Ni-Fe-2000	0.00527	3785V	3783V	3784V	3787V	3782V	3789V	3786V	3781V	3788V	3780V	3783I	3787I	3782I	3789I	3786I	3781I	3788I	3780I	
Pt-10	0.00385	38A5V	38A3V	38A4V	38A7V	38A2V	38A9V	38A6V	38A1V	38A8V	38A0V	38A3I	38A7I	38A2I	38A9I	38A6I	38A1I	38A8I	38A0I	
Pt-10	0.003911	38B5V	38B3V	38B4V	38B7V	38B2V	38B9V	38B6V	38B1V	38B8V	38B0V	38B3I	38B7I	38B2I	38B9I	38B6I	38B1I	38B8I	38B0I	
Pt-10	0.003916	38C5V	38C3V	38C4V	38C7V	38C2V	38C9V	38C6V	38C1V	38C8V	38C0V	38C3I	38C7I	38C2I	38C9I	38C6I	38C1I	38C8I	38C0I	
Pt-10	0.003926	38D5V	38D3V	38D4V	38D7V	38D2V	38D9V	38D6V	38D1V	38D8V	38D0V	38D3I	38D7I	38D2I	38D9I	38D6I	38D1I	38D8I	38D0I	
Pt-25	0.003926	39D5V	39D3V	39D4V	39D7V	39D2V	39D9V	39D6V	39D1V	39D8V	39D0V	39D3I	39D7I	39D2I	39D9I	39D6I	39D1I	39D8I	39D0I	
Pt-50	0.00385	3AA5V	3AA3V	3AA4V	3AA7V	3AA2V	3AA9V	3AA6V	3AA1V	3AA8V	3AA0V	3AA3I	3AA7I	3AA2I	3AA9I	3AA6I	3AA1I	3AA8I	3AA0I	
Pt-50	0.003911	3AB5V	3AB3V	3AB4V	3AB7V	3AB2V	3AB9V	3AB6V	3AB1V	3AB8V	3AB0V	3AB3I	3AB7I	3AB2I	3AB9I	3AB6I	3AB1I	3AB8I	3AB0I	
Pt-50	0.003916	3AC5V	3AC3V	3AC4V	3AC7V	3AC2V	3AC9V	3AC6V	3AC1V	3AC8V	3AC0V	3AC3I	3AC7I	3AC2I	3AC9I	3AC6I	3AC1I	3AC8I	3AC0I	
Pt-50	0.003926	3AD5V	3AD3V	3AD4V	3AD7V	3AD2V	3AD9V	3AD6V	3AD1V	3AD8V	3AD0V	3AD3I	3AD7I	3AD2I	3AD9I	3AD6I	3AD1I	3AD8I	3AD0I	
Pt-100	0.00385	3BA5V	3BA3V	3BA4V	3BA7V	3BA2V	3BA9V	3BA6V	3BA1V	3BA8V	3BA0V	3BA3I	3BA7I	3BA2I	3BA9I	3BA6I	3BA1I	3BA8I	3BA0I	
Pt-100	0.003911	3BB5V	3BB3V	3BB4V	3BB7V	3BB2V	3BB9V	3BB6V	3BB1V	3BB8V	3BB0V	3BB3I	3BB7I	3BB2I	3BB9I	3BB6I	3BB1I	3BB8I	3BB0I	
Pt-100	0.003916	3BC5V	3BC3V	3BC4V	3BC7V	3BC2V	3BC9V	3BC6V	3BC1V	3BC8V	3BC0V	3BC3I	3BC7I	3BC2I	3BC9I	3BC6I	3BC1I	3BC8I	3BC0I	
Pt-100	0.003926	3BD5V	3BD3V	3BD4V	3BD7V	3BD2V	3BD9V	3BD6V	3BD1V	3BD8V	3BD0V	3BD3I	3BD7I	3BD2I	3BD9I	3BD6I	3BD1I	3BD8I	3BD0I	
Pt-200	0.00385	3CA5V	3CA3V	3CA4V	3CA7V	3CA2V	3CA9V	3CA6V	3CA1V	3CA8V	3CA0V	3CA3I	3CA7I	3CA2I	3CA9I	3CA6I	3CA1I	3CA8I	3CA0I	
Pt-200	0.003911	3CB5V	3CB3V	3CB4V	3CB7V	3CB2V	3CB9V	3CB6V	3CB1V	3CB8V	3CB0V	3CB3I	3CB7I	3CB2I	3CB9I	3CB6I	3CB1I	3CB8I	3CB0I	
Pt-200	0.003916	3CC5V	3CC3V	3CC4V	3CC7V	3CC2V	3CC9V	3CC6V	3CC1V	3CC8V	3CC0V	3CC3I	3CC7I	3CC2I	3CC9I	3CC6I	3CC1I	3CC8I	3CC0I</	

For models with "R" option, output ranges are reversed

4 Wire RTD Type	Output	±10 V	0-10 V	±5 V	2-10 V	0-8 V	0-5 V	1-5 V	0-4 V	0-2 V	0-1 V	0-20 mA	4-20 mA	0-16 mA	0-10 mA	2-10 mA	0-8 mA	0-4 mA	0-2 mA
	Switches Curve	ABCDE	ABCDE	ABCDE	ABCDE	ABCDE	ABCDE	ABCDE	ABCDE	ABCDE	ABCDE	ABCDE	ABCDE	ABCDE	ABCDE	ABCDE	ABCDE	ABCDE	ABCDE
Cu-10	0.00427	4185V	4183V	4184V	4187V	4182V	4189V	4186V	4181V	4188V	4180V	4183I	4187I	4182I	4189I	4186I	4181I	4188I	4180I
Cu-100	0.00427	4285V	4283V	4284V	4287V	4282V	4289V	4286V	4281V	4288V	4280V	4283I	4287I	4282I	4289I	4286I	4281I	4288I	4280I
Ni-100	0.00618	4385V	4383V	4384V	4387V	4382V	4389V	4386V	4381V	4388V	4380V	4383I	4387I	4382I	4389I	4386I	4381I	4388I	4380I
Ni-120	0.00672	4485V	4483V	4484V	4487V	4482V	4489V	4486V	4481V	4488V	4480V	4483I	4487I	4482I	4489I	4486I	4481I	4488I	4480I
Ni-Fe-500	0.00518	4585V	4583V	4584V	4587V	4582V	4589V	4586V	4581V	4588V	4580V	4583I	4587I	4582I	4589I	4586I	4581I	4588I	4580I
Ni-Fe-1000	0.00527	4685V	4683V	4684V	4687V	4682V	4689V	4686V	4681V	4688V	4680V	4683I	4687I	4682I	4689I	4686I	4681I	4688I	4680I
Ni-Fe-2000	0.00527	4785V	4783V	4784V	4787V	4782V	4789V	4786V	4781V	4788V	4780V	4783I	4787I	4782I	4789I	4786I	4781I	4788I	4780I
Pt-10	0.00385	48A5V	48A3V	48A4V	48A7V	48A2V	48A9V	48A6V	48A1V	48A8V	48A0V	48A3I	48A7I	48A2I	48A9I	48A6I	48A1I	48A8I	48A0I
Pt-10	0.003911	48B5V	48B3V	48B4V	48B7V	48B2V	48B9V	48B6V	48B1V	48B8V	48B0V	48B3I	48B7I	48B2I	48B9I	48B6I	48B1I	48B8I	48B0I
Pt-10	0.003916	48C5V	48C3V	48C4V	48C7V	48C2V	48C9V	48C6V	48C1V	48C8V	48C0V	48C3I	48C7I	48C2I	48C9I	48C6I	48C1I	48C8I	48C0I
Pt-10	0.003926	48D5V	48D3V	48D4V	48D7V	48D2V	48D9V	48D6V	48D1V	48D8V	48D0V	48D3I	48D7I	48D2I	48D9I	48D6I	48D1I	48D8I	48D0I
Pt-25	0.003926	49D5V	49D3V	49D4V	49D7V	49D2V	49D9V	49D6V	49D1V	49D8V	49D0V	49D3I	49D7I	49D2I	49D9I	49D6I	49D1I	49D8I	49D0I
Pt-50	0.00385	4AA5V	4AA3V	4AA4V	4AA7V	4AA2V	4AA9V	4AA6V	4AA1V	4AA8V	4AA0V	4AA3I	4AA7I	4AA2I	4AA9I	4AA6I	4AA1I	4AA8I	4AA0I
Pt-50	0.003911	4AB5V	4AB3V	4AB4V	4AB7V	4AB2V	4AB9V	4AB6V	4AB1V	4AB8V	4AB0V	4AB3I	4AB7I	4AB2I	4AB9I	4AB6I	4AB1I	4AB8I	4AB0I
Pt-50	0.003916	4AC5V	4AC3V	4AC4V	4AC7V	4AC2V	4AC9V	4AC6V	4AC1V	4AC8V	4AC0V	4AC3I	4AC7I	4AC2I	4AC9I	4AC6I	4AC1I	4AC8I	4AC0I
Pt-50	0.003926	4AD5V	4AD3V	4AD4V	4AD7V	4AD2V	4AD9V	4AD6V	4AD1V	4AD8V	4AD0V	4AD3I	4AD7I	4AD2I	4AD9I	4AD6I	4AD1I	4AD8I	4AD0I
Pt-100	0.00385	4BA5V	4BA3V	4BA4V	4BA7V	4BA2V	4BA9V	4BA6V	4BA1V	4BA8V	4BA0V	4BA3I	4BA7I	4BA2I	4BA9I	4BA6I	4BA1I	4BA8I	4BA0I
Pt-100	0.003911	4BB5V	4BB3V	4BB4V	4BB7V	4BB2V	4BB9V	4BB6V	4BB1V	4BB8V	4BB0V	4BB3I	4BB7I	4BB2I	4BB9I	4BB6I	4BB1I	4BB8I	4BB0I
Pt-100	0.003916	4BC5V	4BC3V	4BC4V	4BC7V	4BC2V	4BC9V	4BC6V	4BC1V	4BC8V	4BC0V	4BC3I	4BC7I	4BC2I	4BC9I	4BC6I	4BC1I	4BC8I	4BC0I
Pt-100	0.003926	4BD5V	4BD3V	4BD4V	4BD7V	4BD2V	4BD9V	4BD6V	4BD1V	4BD8V	4BD0V	4BD3I	4BD7I	4BD2I	4BD9I	4BD6I	4BD1I	4BD8I	4BD0I
Pt-200	0.00385	4CA5V	4CA3V	4CA4V	4CA7V	4CA2V	4CA9V	4CA6V	4CA1V	4CA8V	4CA0V	4CA3I	4CA7I	4CA2I	4CA9I	4CA6I	4CA1I	4CA8I	4CA0I
Pt-200	0.003911	4CB5V	4CB3V	4CB4V	4CB7V	4CB2V	4CB9V	4CB6V	4CB1V	4CB8V	4CB0V	4CB3I	4CB7I	4CB2I	4CB9I	4CB6I	4CB1I	4CB8I	4CB0I
Pt-200	0.003916	4CC5V	4CC3V	4CC4V	4CC7V	4CC2V	4CC9V	4CC6V	4CC1V	4CC8V	4CC0V	4CC3I	4CC7I	4CC2I	4CC9I	4CC6I	4CC1I	4CC8I	4CC0I
Pt-200	0.003926	4CD5V	4CD3V	4CD4V	4CD7V	4CD2V	4CD9V	4CD6V	4CD1V	4CD8V	4CD0V	4CD3I	4CD7I	4CD2I	4CD9I	4CD6I	4CD1I	4CD8I	4CD0I
Pt-470	0.003926	4DD5V	4DD3V	4DD4V	4DD7V	4DD2V	4DD9V	4DD6V	4DD1V	4DD8V	4DD0V	4DD3I	4DD7I	4DD2I	4DD9I	4DD6I	4DD1I	4DD8I	4DD0I
Pt-500	0.00385	4EA5V	4EA3V	4EA4V	4EA7V	4EA2V	4EA9V	4EA6V	4EA1V	4EA8V	4EA0V	4EA3I	4EA7I	4EA2I	4EA9I	4EA6I	4EA1I	4EA8I	4EA0I
Pt-500	0.003911	4EB5V	4EB3V	4EB4V	4EB7V	4EB2V	4EB9V	4EB6V	4EB1V	4EB8V	4EB0V	4EB3I	4EB7I	4EB2I	4EB9I	4EB6I	4EB1I	4EB8I	4EB0I
Pt-500	0.003916	4EC5V	4EC3V	4EC4V	4EC7V	4EC2V	4EC9V	4EC6V	4EC1V	4EC8V	4EC0V	4EC3I	4EC7I	4EC2I	4EC9I	4EC6I	4EC1I	4EC8I	4EC0I
Pt-500	0.003926	4ED5V	4ED3V	4ED4V	4ED7V	4ED2V	4ED9V	4ED6V	4ED1V	4ED8V	4ED0V	4ED3I	4ED7I	4ED2I	4ED9I	4ED6I	4ED1I	4ED8I	4ED0I
Pt-1000	0.00375	4F95V	4F93V	4F94V	4F97V	4F92V	4F99V	4F96V	4F91V	4F98V	4F90V	4F93I	4F97I	4F92I	4F99I	4F96I	4F91I	4F98I	4F90I
Pt-1000	0.00385	4FA5V	4FA3V	4FA4V	4FA7V	4FA2V	4FA9V	4FA6V	4FA1V	4FA8V	4FA0V	4FA3I	4FA7I	4FA2I	4FA9I	4FA6I	4FA1I	4FA8I	4FA0I
Pt-1000	0.003911	4FB5V	4FB3V	4FB4V	4FB7V	4FB2V	4FB9V	4FB6V	4FB1V	4FB8V	4FB0V	4FB3I	4FB7I	4FB2I	4FB9I	4FB6I	4FB1I	4FB8I	4FB0I
Pt-1000	0.003916	4FC5V	4FC3V	4FC4V	4FC7V	4FC2V	4FC9V	4FC6V	4FC1V	4FC8V	4FC0V	4FC3I	4FC7I	4FC2I	4FC9I	4FC6I	4FC1I	4FC8I	4FC0I
Pt-1000	0.003926	4FD5V	4FD3V	4FD4V	4FD7V	4FD2V	4FD9V	4FD6V	4FD1V	4FD8V	4FD0V	4FD3I	4FD7I	4FD2I	4FD9I	4FD6I	4FD1I	4FD8I	4FD0I

For models with "R" option, output ranges are reversed

Date installed	Model	Serial number	Location	Input range	Output range	A	B	C	D	E

Internal Jumper for 4 Wire RTD with Current Rotation Input

To use the 4 wire RTD with current rotation input, an internal jumper must be moved by following the procedure below. This measuring method eliminates errors from parasitic millivolts generated by dissimilar metal connections.

1. Remove all power from the module, unplug all connectors, and remove unit from DIN rail.
2. Using a small flat-blade screwdriver remove the front panel as shown.
3. Note the locations of the seven tabs attaching the side cover.
4. Using a small flat-blade screwdriver gently pry the tab ends away from the housing. Start with the large tab at the rear of the unit, and work towards the front while gently pulling up on the side cover.
5. When all tabs are unlatched, remove the side cover.
6. Pull it out of its holder and place it in the location shown for a thermistor input.
7. Align the side cover and snap into place making sure all seven tabs are engaged. Snap front cover back into place. Reinstall unit.

Cover Removal



Internal Jumper

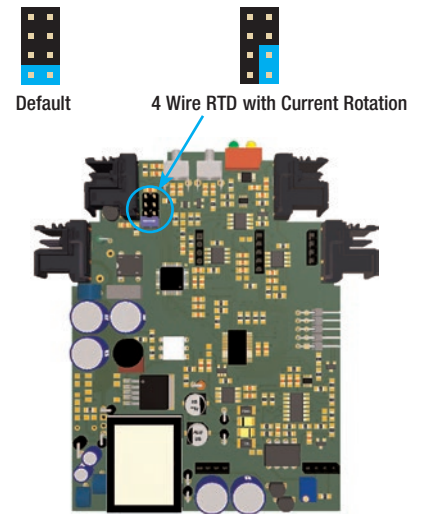

For models with "R" option, output ranges are reversed

4 Wire RTD Current Rotation	Output Switches	±10 V	0-10 V	±5 V	2-10 V	0-8 V	0-5 V	1-5 V	0-4 V	0-2 V	0-1 V	0-20 mA	4-20 mA	0-16 mA	0-10 mA	2-10 mA	0-8 mA	0-4 mA	0-2 mA
		Curve	ABCDE	ABCDE	ABCDE	ABCDE	ABCDE	ABCDE	ABCDE	ABCDE	ABCDE	ABCDE	ABCDE	ABCDE	ABCDE	ABCDE	ABCDE	ABCDE	ABCDE
Cu-10	0.00427	5185V	5183V	5184V	5187V	5182V	5189V	5186V	5181V	5188V	5180V	5183I	5187I	5182I	5189I	5186I	5181I	5188I	5180I
Cu-100	0.00427	5285V	5283V	5284V	5287V	5282V	5289V	5286V	5281V	5288V	5280V	5283I	5287I	5282I	5289I	5286I	5281I	5288I	5280I
Ni-100	0.00618	5385V	5383V	5384V	5387V	5382V	5389V	5386V	5381V	5388V	5380V	5383I	5387I	5382I	5389I	5386I	5381I	5388I	5380I
Ni-120	0.00672	5485V	5483V	5484V	5487V	5482V	5489V	5486V	5481V	5488V	5480V	5483I	5487I	5482I	5489I	5486I	5481I	5488I	5480I
Ni-Fe-500	0.00518	5585V	5583V	5584V	5587V	5582V	5589V	5586V	5581V	5588V	5580V	5583I	5587I	5582I	5589I	5586I	5581I	5588I	5580I
Ni-Fe-1000	0.00527	5685V	5683V	5684V	5687V	5682V	5689V	5686V	5681V	5688V	5680V	5683I	5687I	5682I	5689I	5686I	5681I	5688I	5680I
Ni-Fe-2000	0.00527	5785V	5783V	5784V	5787V	5782V	5789V	5786V	5781V	5788V	5780V	5783I	5787I	5782I	5789I	5786I	5781I	5788I	5780I
Pt-10	0.00385	58A5V	58A3V	58A4V	58A7V	58A2V	58A9V	58A6V	58A1V	58A8V	58A0V	58A3I	58A7I	58A2I	58A9I	58A6I	58A1I	58A8I	58A0I
Pt-10	0.003911	58B5V	58B3V	58B4V	58B7V	58B2V	58B9V	58B6V	58B1V	58B8V	58B0V	58B3I	58B7I	58B2I	58B9I	58B6I	58B1I	58B8I	58B0I
Pt-10	0.003916	58C5V	58C3V	58C4V	58C7V	58C2V	58C9V	58C6V	58C1V	58C8V	58C0V	58C3I	58C7I	58C2I	58C9I	58C6I	58C1I	58C8I	58C0I
Pt-10	0.003926	58D5V	58D3V	58D4V	58D7V	58D2V	58D9V	58D6V	58D1V	58D8V	58D0V	58D3I	58D7I	58D2I	58D9I	58D6I	58D1I	58D8I	58D0I
Pt-25	0.003926	59D5V	59D3V	59D4V	59D7V	59D2V	59D9V	59D6V	59D1V	59D8V	59D0V	59D3I	59D7I	59D2I	59D9I	59D6I	59D1I	59D8I	59D0I
Pt-50	0.00385	5AA5V	5AA3V	5AA4V	5AA7V	5AA2V	5AA9V	5AA6V	5AA1V	5AA8V	5AA0V	5AA3I	5AA7I	5AA2I	5AA9I	5AA6I	5AA1I	5AA8I	5AA0I
Pt-50	0.003911	5AB5V	5AB3V	5AB4V	5AB7V	5AB2V	5AB9V	5AB6V	5AB1V	5AB8V	5AB0V	5AB3I	5AB7I	5AB2I	5AB9I	5AB6I	5AB1I	5AB8I	5AB0I
Pt-50	0.003916	5AC5V	5AC3V	5AC4V	5AC7V	5AC2V	5AC9V	5AC6V	5AC1V	5AC8V	5AC0V	5AC3I	5AC7I	5AC2I	5AC9I	5AC6I	5AC1I	5AC8I	5AC0I
Pt-50	0.003926	5AD5V	5AD3V	5AD4V	5AD7V	5AD2V	5AD9V	5AD6V	5AD1V	5AD8V	5AD0V	5AD3I	5AD7I	5AD2I	5AD9I	5AD6I	5AD1I	5AD8I	5AD0I
Pt-100	0.00385	5BA5V	5BA3V	5BA4V	5BA7V	5BA2V	5BA9V	5BA6V	5BA1V	5BA8V	5BA0V	5BA3I	5BA7I	5BA2I	5BA9I	5BA6I	5BA1I	5BA8I	5BA0I
Pt-100	0.003911	5BB5V	5BB3V	5BB4V	5BB7V	5BB2V	5BB9V	5BB6V	5BB1V	5BB8V	5BB0V	5BB3I	5BB7I	5BB2I	5BB9I	5BB6I	5BB1I	5BB8I	5BB0I
Pt-100	0.003916	5BC5V	5BC3V	5BC4V	5BC7V	5BC2V	5BC9V	5BC6V	5BC1V	5BC8V	5BC0V	5BC3I	5BC7I	5BC2I	5BC9I	5BC6I	5BC1I	5BC8I	5BC0I
Pt-100	0.003926	5BD5V	5BD3V	5BD4V	5BD7V	5BD2V	5BD9V	5BD6V	5BD1V	5BD8V	5BD0V	5BD3I	5BD7I	5BD2I	5BD9I	5BD6I	5BD1I	5BD8I	5BD0I
Pt-200	0.00385	5CA5V	5CA3V	5CA4V	5CA7V	5CA2V	5CA9V	5CA6V	5CA1V	5CA8V	5CA0V	5CA3I	5CA7I	5CA2I	5CA9I	5CA6I	5CA1I	5CA8I	5CA0I
Pt-200	0.003911	5CB5V	5CB3V	5CB4V	5CB7V	5CB2V	5CB9V	5CB6V	5CB1V	5CB8V	5CB0V	5CB3I	5CB7I	5CB2I	5CB9I	5CB6I	5CB1I	5CB8I	5CB0I
Pt-200	0.003916	5CC5V	5CC3V	5CC4V	5CC7V	5CC2V	5CC9V	5CC6V	5CC1V	5CC8V	5CC0V	5CC3I	5CC7I	5CC2I	5CC9I	5CC6I	5CC1I	5CC8I	5CC0I
Pt-200	0.003926	5CD5V	5CD3V	5CD4V	5CD7V	5CD2V	5CD9V	5CD6V	5CD1V	5CD8V	5CD0V	5CD3I	5CD7I	5CD2I	5CD9I	5CD6I	5CD1I	5CD8I	5CD0I
Pt-470	0.003926	5DD5V	5DD3V	5DD4V	5DD7V	5DD2V	5DD9V	5DD6V	5DD1V	5DD8V	5DD0V	5DD3I	5DD7I	5DD2I	5DD9I	5DD6I	5DD1I	5DD8I	5DD0I
Pt-500	0.00385	5EA5V	5EA3V	5EA4V	5EA7V	5EA2V	5EA9V	5EA6V	5EA1V	5EA8V	5EA0V	5EA3I	5EA7I	5EA2I	5EA9I	5EA6I	5EA1I	5EA8I	5EA0I
Pt-500	0.003911	5EB5V	5EB3V	5EB4V	5EB7V	5EB2V	5EB9V	5EB6V	5EB1V	5EB8V	5EB0V	5EB3I	5EB7I	5EB2I	5EB9I	5EB6I	5EB1I	5EB8I	5EB0I
Pt-500	0.003916	5EC5V	5EC3V	5EC4V	5EC7V	5EC2V	5EC9V	5EC6V	5EC1V	5EC8V	5EC0V	5EC3I	5EC7I	5EC2I	5EC9I	5EC6I	5EC1I	5EC8I	5EC0I
Pt-500	0.003926	5ED5V	5ED3V	5ED4V	5ED7V	5ED2V	5ED9V	5ED6V	5ED1V	5ED8V	5ED0V	5ED3I	5ED7I	5ED2I	5ED9I	5ED6I	5ED1I	5ED8I	5ED0I
Pt-1000	0.00375	5F95V	5F93V	5F94V	5F97V	5F92V	5F99V	5F96V	5F91V	5F98V	5F90V	5F93I	5F97I	5F92I	5F99I	5F96I	5F91I	5F98I	5F90I
Pt-1000	0.00385	5FA5V	5FA3V	5FA4V	5FA7V	5FA2V	5FA9V	5FA6V	5FA1V	5FA8V	5FA0V	5FA3I	5FA7I	5FA2I	5FA9I	5FA6I	5FA1I	5FA8I	5FA0I
Pt-1000	0.003911	5FB5V	5FB3V	5FB4V	5FB7V	5FB2V	5FB9V	5FB6V	5FB1V	5FB8V	5FB0V	5FB3I	5FB7I	5FB2I	5FB9I	5FB6I	5FB1I	5FB8I	5FB0I
Pt-1000	0.003916	5FC5V	5FC3V	5FC4V	5FC7V	5FC2V	5FC9V	5FC6V	5FC1V	5FC8V	5FC0V	5FC3I	5FC7I	5FC2I	5FC9I	5FC6I	5FC1I	5FC8I	5FC0I
Pt-1000	0.003926	5FD5V	5FD3V	5FD4V	5FD7V	5FD2V	5FD9V	5FD6V	5FD1V	5FD8V	5FD0V	5FD3I	5FD7I	5FD2I	5FD9I	5FD6I	5FD1I	5FD8I	5FD0I

Range Table: Custom Input Range

For models with "R" option, output ranges are reversed

Custom Input	Output Switches	±10 V	0-10 V	±5 V	2-10 V	0-8 V	0-5 V	1-5 V	0-4 V	0-2 V	0-1 V	0-20 mA	4-20 mA	0-16 mA	0-10 mA	2-10 mA	0-8 mA	0-4 mA	0-2 mA
		Curve	ABCDE	ABCDE	ABCDE	ABCDE	ABCDE	ABCDE	ABCDE	ABCDE	ABCDE	ABCDE	ABCDE	ABCDE	ABCDE	ABCDE	ABCDE	ABCDE	ABCDE
See module side label		FF85V	FF83V	FF84V	FF87V	FF82V	FF89V	FF86V	FF81V	FF88V	FF80V	FF83I	FF87I	FF82I	FF89I	FF86I	FF81I	FF88I	FF80I