

Control Input: 0-50 mV to 0-10 VDC, 0-1 mA to 0-20 mA, 4-20 mA
Output: 8 A SPDT Relay with Neutral Position

Position Feedback: Potentiometer

Quick Link: api-usa.com/3280

- Automatic or Manual Valve Control
- Test/Manual Positioning Buttons
- Input LoopTracker® LED
- Relay Status LEDs
- High Capacity Relay Contacts
- One Minute Field Setup
- Removable Plugs for Faster Installation
- Input/Power Isolation



[Applications Link
api-usa.com/apps](http://Applications Link api-usa.com/apps)

Free Factory I/O Setup!

1 Minute Setup!

Applications

- Valve Position Controller
- Linear Actuator Controller
- Damper Controller

Control Input

	Minimum Span	Maximum Span
Voltage:	0-50 mVDC	0-10 VDC
Current:	0-1 mAADC	0-20 mAADC
	1 VDC maximum burden @ 20 mA	

Control Input Impedance

Voltage:	250 kΩ min.
Current:	50 Ω typical

Common Mode Rejection

100 dB minimum

Input Calibration

Multi-turn zero and span potentiometers
 ±10% of span adjustment range typical

Loop Power Supply

15 VDC ±10%, 25 mA max. to power external loads such as loop powered transmitters, sensors, etc.

Feedback Potentiometer Range

Any full range potentiometer 0-100 Ω to 0-100 kΩ
 Potentiometer excitation: 1.0 VDC nominal, 10 mA maximum

Manual Controls

Automatic/manual switch
 Manual open and close buttons

LoopTracker

Variable brightness LEDs for input level and status

Relay Output

SPDT relay with neutral contact position
 8 A max @ 240 VAC resistive load
 An RC snubber is recommended for inductive loads

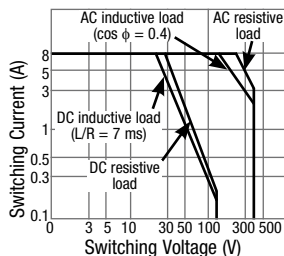

Deadband

12 turn potentiometer adjustable from 1 to 25% of span

Response Time

100 milliseconds typical

Isolation

Power to input isolation

Housing and Connectors

IP 40, requires installation in panel or enclosure
 For use in Pollution Degree 2 Environment
 Mount vertically to a 35 mm DIN rail
 Four 4-terminal removable connectors, 14 AWG max wire size

Ambient Temperature Range and Stability

-10°C to +60°C operating ambient
 Better than ±0.02% of span per °C stability

Power

85-265 VAC, 50/60 Hz or 60-300 VDC, 2 W maximum
 D versions: 9-30 VDC or 10-32 VAC 50/60 Hz, 2 W maximum

8 A max Relay Output with Neutral Position

Potentiometer or Slidewire Feedback

Zero and Span for Input

Relay Status LED

Adjustable Relay Deadband

Input LoopTracker LED

Auto/Manual Switch

Manual Open/Close Buttons

24 Switch Selectable Input Ranges

Connect Sink or Source mA Input

Universal Power

1 2 3 4

5 6 7 8

9 10 11 12

13 14 15 16

Removable Plugs



See Wiring Diagrams on Next Page

See API 3200 G or APD 3200 for 4-20 mA or Voltage Feedback

Dimensions

0.89" W x 4.62" H x 4.81" D
 22.5 mm W x 117 mm H x 122 mm D
 Height includes connectors

Description

The APD 3280 controls the position of a valve or linear actuator by comparing a DC input (control signal) to that of a position feedback potentiometer or slidewire.

An SPDT relay provides bi-directional (open-close) signals to drive a motor to open or close a valve. A bi-color LED indicates the Open/Close relay contact status.

When the valve position, as indicated by the feedback potentiometer, becomes equal to the position as represented by the control input, the relay will go to the neutral position and the motor will halt. A multi-turn deadband control allows precise tuning of the motor response to eliminate hunting or oscillation.

Heavy-duty relay contacts allow the module to directly control high capacity loads as long as the switching current with within the limits shown at left.

How to Order

Models are field rangeable. Switches can pre-set to your specifications. See range table on other side.

Any full range feedback potentiometer or slidewire from 0-100 Ω to 0-100 kΩ can be used, no need to specify range. Order APD 3280 D for operation on low voltage power.

Please Specify

Model
 Control input range (if factory is to pre-set switches)
 Options as required

Auto/Manual Switch

An Auto/Manual switch allows either closed-loop automatic valve position control or manual positioning via the Open/Close buttons.

The manual mode is useful for troubleshooting, calibration, system testing or as a manual bypass.

LoopTracker

A green LoopTracker LED varies in intensity with changes in the control input signal. Monitoring this LED can provide a quick visual picture of your process at all times and save time during initial startup and/or troubleshooting.

Model	Description	Power
APD 3280	Field configurable valve positioner for potentiometer or slidewire feedback.	60-265 VAC or 85-300 VDC
APD 3280 D	8 A max. SPDT relay output	9-30 VDC or 10-32 VAC

Options and Accessories

Optional—add to end of model number

U Conformal coating for moisture resistance

Accessory—order as separate line item

API BP4 Spare removable 4 terminal plug, black

Precautions

WARNING! All wiring must be performed by a qualified electrician or instrumentation engineer. See diagram for terminal designations and wiring examples. Consult factory for assistance.

WARNING! Avoid shock hazards! Turn signal input, output, and power off before connecting or disconnecting wiring, or removing or installing module.

Précautions

ATTENTION! Tout le câblage doit être effectué par un électricien ou ingénieur en instrumentation qualifié. Voir le diagramme pour désignations des bornes et des exemples de câblage. Consulter l'usine pour assistance.

ATTENTION! Éviter les risques de choc! Fermez le signal d'entrée, le signal de sortie et l'alimentation électrique avant de connecter ou de déconnecter le câblage, ou de retirer ou d'installer le module.

API maintains a constant effort to upgrade and improve its products. Specifications are subject to change without notice. See api-usa.com for latest product information. Consult factory for your specific requirements.

 **WARNING:** This product can expose you to chemicals including nickel, which are known to the State of California to cause cancer or birth defects or other reproductive harm. For more information go to www.P65Warnings.ca.gov

Range Selection

Select input range before installing the module on the DIN rail. The module side label and the table below and list the input ranges. Special ranges will be shown on the module model/serial number label.

Use slide switch "A" and rotary switches "B" and "C" on the side of the module to select the input range to match your application.

Switch A: Set to "V" for voltage input or Set to "I" for current input

Switch B: Input range

Switch C: Input offset

For ranges that fall between the listed ranges use the next highest setting and trim the input signal with the zero and span potentiometers as described in the Calibration section.

Input	Switch		
	A	B	C
0-50 mV	V	8	0
0-100 mV	V	9	0
0-200 mV	V	A	0
0-250 mV	V	C	0
0-400 mV	V	B	0
0-500 mV	V	0	0
0-1 V	V	1	0
0-2 V	V	2	0
0-2.5 V	V	4	0
0-4 V	V	3	0
1-5 V	V	3	E
0-5 V	V	5	0
0-10 V	V	6	0
±5 V	V	6	5
±10 V	V	7	5
0-1 mA	I	C	0
0-2 mA	I	0	0
0-4 mA	I	1	0
0-8 mA	I	2	0
2-10 mA	I	2	E
0-10 mA	I	4	0
0-16 mA	I	3	0
4-20 mA	I	3	E
0-20 mA	I	5	0

Feedback Signal

Any full-range (zero to max.) potentiometer within the specified ranges may be used.

Type of Input Device	- Terminal	+ Terminal
Voltage signal	9 (-)	11 (+)
mA (current) signal that provides power to the current loop. Typically a 3 or 4-wire transmitter.	9 (-)	11 (+)
mA (current) signal that is unpowered. Typically a 2-wire device. APD module provides loop power.	11 (-)	10 (+15 V)

Relay Output

Use an appropriate RC snubber if the inductive load exceeds relay specifications. See Relay Rating chart on other side.

Input Connections

Polarity must be observed when connecting the signal input.

Module Power Terminals

Check model/serial number label for module operating voltage to make sure it matches available power.

When using DC power, either polarity is acceptable, but for consistency, wire positive (+) to terminal 25 and negative (-) to terminal 28.

Mounting to a DIN Rail

Install module vertically on a 35 mm DIN rail in a protective enclosure away from heat sources. Do not block air flow. Allow 1" (25 mm) above and below housing vents for air circulation.

1. Tilt front of module down and position the lower spring clips against the bottom edge of DIN rail.
2. Push front of module upward until upper mount snaps into place.

Removal

Avoid shock hazards! Turn signal input, output, and power off.

1. Push up on bottom back of module.
2. Tilt front of module downward to release upper mount from top edge of DIN rail.
3. The module can now be removed from the DIN rail.

Calibration

For most applications the deadband is the only required adjustment.

Note: Perform the following calibration procedure any time switch settings are changed.

1. Deadband is normally adjusted after installation is complete.
2. Turn the deadband potentiometer counterclockwise to minimum.
3. Provide a near mid-level control input signal.
4. Allow the valve to stabilize.
5. If overshoot, oscillation, or hunting are detected, slowly increase the deadband clockwise to eliminate the oscillation.

Input zero and span normally do not need to be adjusted.

1. If adjustment is required, apply a control input that represents the fully closed position.
2. Adjust the zero control to just close the valve.
3. Apply a full open control input signal.
4. Adjust the span control to just fully open the valve.

Operation

The APD 3280 provides an excitation voltage to the feedback potentiometer on the valve actuator and monitors its position. If the difference between the control signal and the feedback signal is greater than the deadband setting, the appropriate relay contact is energized to actuate the positioning motor.

Green LoopTracker® Input LED—Provides a visual indication that a signal is being sensed by the input circuitry of the module. It also indicates the input signal strength by changing in intensity as the process changes from minimum to maximum to provide a quick visual picture of your process loop at all times.

If the LED fails to illuminate, or fails to change in intensity as the process changes, this may indicate a problem with module power or signal input wiring. This features greatly aid in saving time during initial start-up or troubleshooting.

Control Relays—An electronic lockout circuit is used to prevent both relay contacts from closing simultaneously. When the input and the feedback signals are equal, the relay contacts will go to the neutral position.

Bi-Color Relay LED—Provides a visual indication of the relay status.

- Green LED Valve opening relay position
- Red LED Valve closing relay position
- LED off Neutral position

Manual/Auto Mode—Switching to Manual allows the Open and Close buttons to be used to position the valve manually independent of the control and feedback signals.

The manual mode is useful for troubleshooting, calibration, system testing, or as a manual bypass. The bi-color relay LED indicates the controller's Open/Close relay contact status.

Switching to Auto mode allows normal operation.

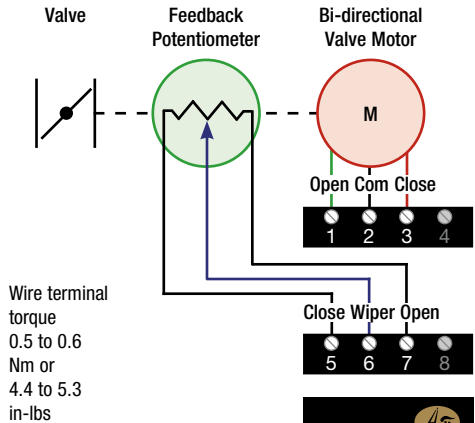

To avoid damage to the module, do not make any connections to unused terminals

To maintain full isolation avoid combining power supplies in common with input, output, or unit power.

Voltage Input

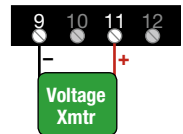
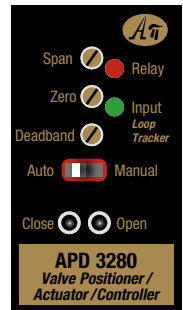

mA input: determine if transmitter has a passive or powered output. The module can be wired for a sinking or sourcing mA input.

Current Sinking Input

Module mA input is unpowered

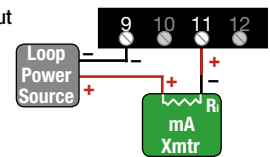

Current Sourcing Input

Module powers mA input loop

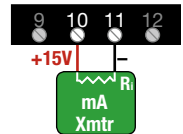

Cu 60/75°C conductors 14 AWG max.

