

**Channel 1: Frequency to DC**

**Channel 2: Bridge/Strain Gauge/Load Cell to DC**

- Two Independent Channels with Full Isolation
- Zero and Span for Each Output
- Input and Output LoopTracker® LEDs
- Output Test/Manual Override for Each Channel
- Built-In I/O Power Supplies

**Applications**

- Monitor Speed and Weight or Pressure
- Convert/Isolate Dual Output Transmitters

**Channel 1 Frequency Input Range**

Factory configured, please specify input range  
 Frequency: 0-25 Hz to 0-20 kHz  
 Any waveform with 5 microsecond min. pulse, 100 mV min. amplitude change, 100 mV to 150 VRMS amplitude

**Channel 1 Sensor Power Supply**

15 VDC ±10%, regulated, 25 mA DC, <10 mVRMS max. ripple

**Channel 1 Characteristics**

Impedance at max. sensitivity: 10 kΩ nom.  
 Impedance at min. sensitivity: 100 kΩ nom.  
 Sensitivity/hysteresis adjustment: Multi-turn potentiometer  
 Sensitivity/hysteresis range: ±25 mV to ±2.5 V typical  
 Normal mode protection: 200% of input rating  
 Common mode protection: 600 V input to ground

**Channel 2 Bridge Input Range**

Factory configured, please specify sensor mV/V and mV range  
 Sensor range: 0-1 mV to 0-2000 mV  
 Millivolt output range is determined by the sensitivity of the sensor (mV/V) and the excitation voltage applied.  
 mV/V sensitivity X excitation voltage = total mV range  
 Input impedance: 1 MΩ minimum  
 Input common mode rejection: 100 dB minimum

**Channel 2 Excitation Voltage**

Range: 4 to 10 VDC factory set, please specify  
 Adjustment: ±10% via front potentiometer  
 Maximum output: 10 VDC maximum at 30 mA  
 Stability: ±0.01% per °C  
 Designed for one 350 Ω (or greater) sensor

**LoopTracker**

Variable brightness LEDs indicate I/O levels for each channel

**Channel 1 and Channel 2 Output Ranges**

Factory configured, please specify for each output channel  
 Voltage: 0-1 VDC to 0-10 VDC, 10 mA max up to 20 VDC with M19, M29, M39  
 Bipolar voltage: ±1 VDC to ±10 VDC  
 Current: 0-1 mA DC to 0-25 mA DC, 4-20 mA DC  
 20 V compliance, 1000 Ω at 20 mA

**Output Calibration**

Multi-turn zero and span potentiometers for each output channel  
 ±15% of span adjustment range typical

**Output Characteristics**

Linearity: ±0.1% of span  
 Temperature stability: Better than 0.04% span/°C  
 Output ripple and noise: Less than 10 mVRMS

**Isolation**

Full 5-way, 1200 VRMS minimum

**Response Time**

70 milliseconds typical

**Output Loop Power Supplies**

20 VDC nominal, regulated, 25 mA DC for each output channel  
 May be selectively wired for sinking or sourcing mA output

**Output Test**

Front buttons set each output to test level when pressed  
 Each test level potentiometer adjustable 0-100% of span

**Installation Environment**

Mount vertically to a 35 mm DIN rail  
 For use in Pollution Degree 2 Environment  
 IP 40 housing, requires installation inside an enclosure  
 -10°C to +60°C operating ambient

**Connectors**

Eight 4-terminal removable connectors, 14 AWG max wire size



**Quick Link**  
[api-usa.com/2000](http://api-usa.com/2000)

**Free Factory I/O Setup!**

**Dimensions**

1.78" W x 4.62" H x 4.81" D  
 45 mm W x 117 mm H x 122 mm D  
 Height includes connectors

**Power**

85-265 VAC, 50/60 Hz or 60-300 VDC, 6 W maximum  
 D versions: 9-30 VDC or 10-32 VAC 50/60 Hz, 6 W maximum

**Description**

The APD 2075 DuoPak accepts one frequency and one strain gauge input and provides two optically isolated DC voltage or current outputs that are linearly related to the inputs.

The input ranges and the output ranges for each channel are independent and can be specified as required. This provides an economical two channel solution in one device.

Typical applications include signal conversion, isolation, and redundancy (i.e. to prevent failure of the entire loop if one device fails), or a combination of these.

Each input signal is filtered, amplified, and then passed through an opto-coupler to the output stages. Full 5-way isolation (input 1, input 2, output 1, output 2, power) make this module useful for ground loop elimination, common mode signal rejection, and noise pickup reduction.

**Output Sink/Source Versatility**

Standard on the APD 2075 are 20 VDC loop excitation supplies for each output channel. These power supplies can be selectively wired for sinking or sourcing allowing use with any combination of powered or unpowered milliamp I/O devices.

**How to Order**

Models are factory ranged. See I/O ranges above left.  
 Ranges and options for each channel must be specified on order

**Channel 1 input range**

**Channel 2 input range, excitation voltage**

**Channel 1 output range**

**Channel 2 output range**

Model	Description	Power
APD 2075	DuoPak 2 channel Freq.-DC, Strain-DC converter/isolator/transmitter	85-265 VAC, 50/60 Hz or 60-300 VDC
APD 2075 D		9-30 VDC or 10-32 VAC

Sink or Source mA Output for Each Channel

Output LoopTracker LED for Each Channel

Adjustable Output Test Function for Each Channel

Zero and Span for Each Channel

Input LoopTracker LED for Each Channel

Custom I/O Ranges

Sensor Input Power Available for Frequency  
 Built-in Excitation Voltage for Strain Gauge Input



Removable Plugs

Universal Power

See Wiring Diagrams on Next Page

**LoopTracker**

API exclusive features include four LoopTracker LEDs (green for each input, red for each output) that vary in intensity with changes in the process input and output signals.

These provide a quick visual picture of your process loop at all times and can greatly aid in saving time during initial startup and troubleshooting.

**Output Test**

An API exclusive feature includes output test buttons for each channel to provide a fixed output (independent of the input) when held depressed.

Terminals are also provided to operate the test functions remotely for each channel. This also allows use as a remote manual override to provide a temporary fixed output if desired. The test output level for each channel is potentiometer adjustable from 0 to 100% of the output span. The output test greatly aids in saving time during initial startup and/or troubleshooting.

**Options and Accessories**

**Options—add to end of model number**

- R1 Channel 1 I/O reversal (i.e. 20-4 mA out)
- R2 Channel 2 I/O reversal (i.e. 20-4 mA out)
- R3 Channel 1 and channel 2 I/O reversal
- M19 Channel 1 high voltage output >10 V up to 20 V
- M29 Channel 2 high voltage output >10 V up to 20 V
- M39 Channel 1 and channel 2 high voltage output
- U Conformal coating for moisture resistance

**Accessory—order as separate line item**

- API BP4 Spare removable 4 terminal plug, black

**Precautions**

WARNING! All wiring must be performed by a qualified electrician or instrumentation engineer. See diagram for terminal designations and wiring examples. Consult factory for assistance.

WARNING! Avoid shock hazards! Turn signal input, output, and power off before connecting or disconnecting wiring, or removing or installing module.

**Précautions**

ATTENTION! Tout le câblage doit être effectué par un électricien ou ingénieur en instrumentation qualifié. Voir le diagramme pour désignations des bornes et des exemples de câblage. Consulter l'usine pour assistance.

ATTENTION! Éviter les risques de choc! Fermez le signal d'entrée, le signal de sortie et l'alimentation électrique avant de connecter ou de déconnecter le câblage, ou de retirer ou d'installer le module.

API maintains a constant effort to upgrade and improve its products. Specifications are subject to change without notice. See [api-usa.com](http://api-usa.com) for latest product information. Consult factory for your specific requirements.

 **WARNING:** This product can expose you to chemicals including nickel, which are known to the State of California to cause cancer or birth defects or other reproductive harm. For more information go to [www.P65Warnings.ca.gov](http://www.P65Warnings.ca.gov)

**Electrical Connections**

Polarity must be observed for signal wiring connections. If the input and/or output do not function, check wiring and polarity.

Each product is factory configured to your exact input and output ranges as indicated on the serial number label.

**Outputs**

For milliamp ranges determine if your devices provide power to the current loop or if the loop must be powered by the APD module. Typical voltage may be 9-24 VDC at your device's terminals if it provides power to the loop.

Device for Output Channel 1	Terminal	Terminal
Voltage input device.	3 (-)	4 (+)
Unpowered or passive mA input device. APD module provides the loop power.	3 (-)	4 (+20 V)
mA input device powers the current loop.	2 (-)	3 (+)
Device for Output Channel 2	Terminal	Terminal
Voltage input device.	7 (-)	8 (+)
Unpowered or passive mA input device. APD module provides the loop power.	7 (-)	8 (+20 V)
mA input device powers the current loop.	6 (-)	7 (+)

**Input 1, Frequency**

The input range is pre-configured at the factory. No input calibration is necessary. The frequency input is compatible with most types of sensors that produce a minimum 100 mV amplitude change and a minimum 5 microsecond pulse width.

A 15 VDC supply is available to power the sensor if required. Always refer to the sensor manufacturer's data sheet to determine supply voltage compatibility and proper wiring.

Frequency Sensor	Ch. 1	Signal Com.	Sensor Power	Signal Input
2 wire or Namur requiring external power	n/a	18 (+15 V)	19 (+)	
2 wire self generating (VR)	17 (-)	n/a	19 (+)	
3 wire PNP or NPN	17 (-)	18 (+15 V)	19 (+)	

**Sensor Load**

The frequency signal input is capacitively coupled to prevent any DC in the input. Some sensors, typically those without an internal load resistor, require a resistive load in order to function.

The resistor value may be specified by the sensor manufacturer as the "minimum resistive load" or calculated from the sensor manufacturer's specified "load current range".

The 15 VDC power supply is capable of providing 25 mA. A load current range of 3 mA to 25 mA would typically use a 5 kΩ to 500 Ω resistor.

**Input 2, Bridge, Strain Gauge, Load Cell**

Refer to wiring diagram at right and strain gauge manufacturer's data sheet for wiring and color-coding. Polarity must be observed when connecting input. Sensor shield wire (if equipped) should be grounded at one end only.

The excitation voltage is factory set and should match the sensor manufacturer's recommendations. A front potentiometer allows approximately ±10% fine adjustment of the excitation voltage. CAUTION: Never short the excitation leads together. This will cause internal damage to the module.

Bridge Input Channel 2	- Terminal	+ Terminal
Strain gauge signal input	21 (+)	23 (-)
Excitation voltage	22 (-)	24 (+)

**Module Power Terminals**

Check label for module operating voltage to make sure it matches available power. The power supplies are fuse protected and the unit may be returned to API for fuse replacement.

When using DC power, either polarity is acceptable, but for consistency, wire positive (+) to terminal 25 and negative (-) to terminal 28.

**Mounting to a DIN Rail**

Install module vertically on a 35 mm DIN rail in a protective enclosure away from heat sources. Do not block air flow. Allow 1" (25 mm) above and below housing vents for air circulation.

1. Tilt front of module down and position the lower spring clips against the bottom edge of DIN rail.
2. Push front of module upward until upper mount snaps into place.

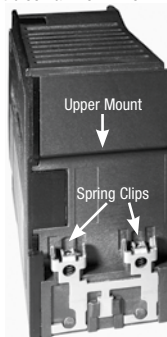

**Removal**

Avoid shock hazards! Turn signal input, output, and power off.

1. Push up on bottom back of module.
2. Tilt front of module downward to release upper mount from top edge of DIN rail.
3. The module can now be removed from the DIN rail.

**Calibration**

Front-mounted Zero and Span potentiometers for each channel can be used to compensate for load and lead variations.

1. Apply power to the module and allow min. 30 minute warm up time.
2. Using an accurate voltmeter on terminals 22 and 24 adjust the excitation voltage fine adjustment potentiometer to the strain gauge manufacturer's recommended value.
3. Using an accurate calibration source, provide an input to the module equal to the minimum input required for the application.
4. Using an accurate measurement device for the output, adjust the Zero potentiometer for the exact minimum output desired. The Zero control should only be adjusted when the input signal is at its minimum. This will produce the corresponding minimum output signal. For example: 4 mA for a 4-20 mA output or -10 V for a ±10 V output.
5. Set the input at maximum, and then adjust the Span pot for the exact maximum output desired. The Span control should only be adjusted when the input signal is at its maximum. This will produce the corresponding maximum output signal. Example: for 4-20 mA output, set the Span control to 20 mA.
6. Repeat adjustments for both channels for maximum accuracy.

**Ch. 1 Sensitivity Adjustment**

A multi-turn potentiometer provides an adjustable threshold level that the incoming signal must overcome before an output can be produced. This is used to limit noise and minimize false input signals that may cause erroneous readings.

Fully clockwise: (max. sensitivity), input threshold is ±25 mV.

Fully counterclockwise: (min. sensitivity), input threshold is ±2.5 volts.

**Output Test Function**

When the Test button is depressed it will drive the output with a known good signal that can be used as a diagnostic aid during initial start-up or troubleshooting. When released, the output will return to normal.

Each Test Cal. potentiometer is factory set to approximately 50% output. Each can be adjusted to set the test output from 0 to 100% of the output span. Press and hold the Test button and adjust the corresponding Test Cal. potentiometer for the desired output level.

They may optionally be externally wired for remote test operation or a manual override. See wiring diagram at right.

**Operation**

The APD 2075 accepts one frequency and one strain gauge input and provides two optically isolated DC voltage or current outputs that are linearly related to the inputs.

Green LoopTracker® input LEDs provide a visual indication that each signal is being sensed by the input circuitry of the module. They also indicates the input signal strength by changing in intensity as the process changes from minimum to maximum.

If an LED fails to illuminate, or fails to change in intensity as the process changes, check the module power or signal input wiring.

Two red LoopTracker output LEDs provide a visual indication that the output signals are functioning. They become brighter as the input and each corresponding output change from minimum to maximum.

For a current output the red LED will only light if the output loop current path is complete. For either current or voltage outputs, failure to illuminate or a failure to change in intensity as the process changes may indicate a problem with the module power or signal output wiring. Note that it may be difficult to see the LEDs under bright lighting conditions.

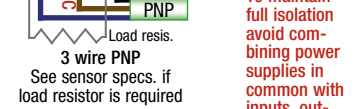
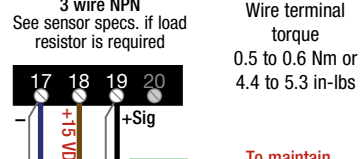
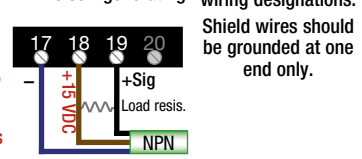
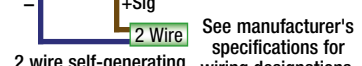
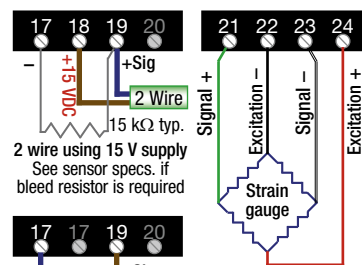
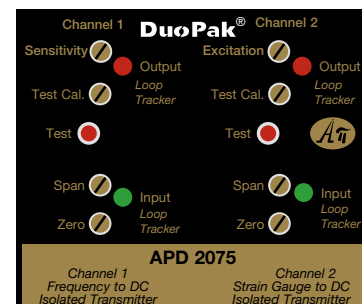
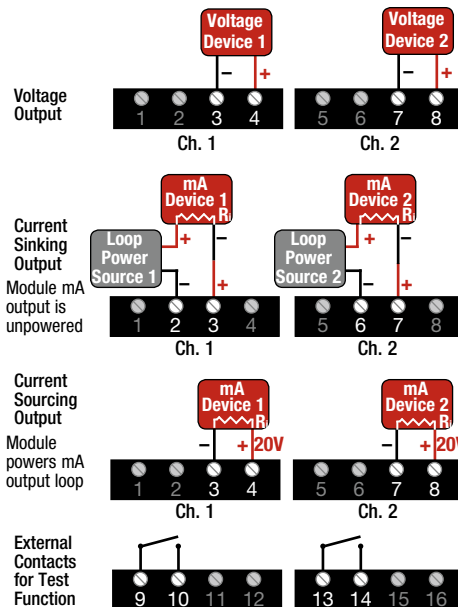

To avoid damage to the module, do not make any connections to unused terminals

See manufacturer's specifications for wiring designations. Shield wires should be grounded at one end only.

Wire terminal torque  
 0.5 to 0.6 Nm or  
 4.4 to 5.3 in-lbs

To maintain full isolation avoid combining power supplies in common with inputs, outputs, or unit power.