

Channel 1: AC to DC

Channel 2: RTD Temperature to DC

- Two Independent Channels with Full Isolation
- Zero and Span for Each Output
- Input and Output LoopTracker® LEDs
- Output Test/Manual Override for Each Channel
- Built-In I/O Power Supplies

Applications

- Monitor an AC Signal and RTD Temperature
- Convert/Isolate Dual Output Transmitters

Channel 1 AC Input Range

Factory configured, please specify input type and range
 Voltage: 0-50 mVAC to 0-300 VAC
 Current: 0-1 mAAC to 0-1000 mAAC
 Measurement type: True RMS
 Frequency: 40 Hz to 1000 Hz sinusoidal
 Voltage input impedance: 220 kΩ minimum
 Current input voltage burden: 1.0 V_{RMS} maximum

Channel 2 RTD Input Range

Factory configured, please provide complete sensor specifications and temperature range. 100°F (55°C) minimum span.

RTD input: Resistance at 0°C
 Curve (385, 3916, 392 etc.)
 Temperature range in °F or °C

RTD resistance: Typically 10 Ω to 2000 Ω, 2 or 3 wire
 Excitation current: Typically 10 Ω: 10 mA, 100 Ω: 2 mA,
 1000 Ω: 0.5 mA, 2000 Ω: 0.2 mA

Leadwire comp.: < ±0.05% of span per 1 Ω change in leadwire resistance, 3 wire sensor

LoopTracker

Variable brightness LEDs indicate I/O levels for each channel

Channel 1 and Channel 2 Output Ranges

Factory configured, please specify for each output channel
 Voltage: 0-1 VDC to 0-10 VDC, 10 mA max up to 20 VDC with M19, M29, M39
 Bipolar voltage: ±1 VDC to ±10 VDC
 Current: 0-1 mADC to 0-25 mADC, 4-20 mADC
 20 V compliance, 1000 Ω at 20 mA

Output Calibration

Multi-turn zero and span potentiometers for each output channel ±15% of span adjustment range typical

Output Characteristics

Linearity: ±0.1% of span
 Temperature stability: Better than 0.04% span/°C
 Output ripple and noise: Less than 10 mVRMS

Isolation

Full 5-way, 1200 V_{RMS} minimum

Response Time

70 milliseconds typical

Output Loop Power Supplies

20 VDC nominal, regulated, 25 mADC for each output channel
 May be selectively wired for sinking or sourcing mA output

Output Test

Front buttons set each output to test level when pressed
 Each test level potentiometer adjustable 0-100% of span

Installation Environment

Mount vertically to a 35 mm DIN rail
 For use in Pollution Degree 2 Environment
 IP 40 housing, requires installation inside an enclosure
 -10°C to +60°C operating ambient

Connectors

Eight 4-terminal removable connectors, 14 AWG max wire size

Power

85-265 VAC, 50/60 Hz or 60-300 VDC, 6 W maximum
 D versions: 9-30 VDC or 10-32 VAC 50/60 Hz, 6 W maximum



Quick Link
api-usa.com/2000

Free Factory
 I/O Setup!

Dimensions

1.78" W x 4.62" H x 4.81" D
 45 mm W x 117 mm H x 122 mm D
 Height includes connectors

Description

The APD 2061 DuoPak accepts one AC voltage or current input and one RTD input and provides two optically isolated DC voltage or current outputs that are linearly related to the inputs.

The input ranges and the output ranges for each channel are independent and can be specified as required. This provides an economical two channel solution in one device.

Typical applications include signal conversion, isolation, and redundancy (i.e. to prevent failure of the entire loop if one device fails), or a combination of these.

Each input signal is filtered, amplified, and then passed through an opto-coupler to the output stages. Full 5-way isolation (input 1, input 2, output 1, output 2, power) make this module useful for ground loop elimination, common mode signal rejection, and noise pickup reduction.

Output Sink/Source Versatility

Standard on the APD 2061 are 20 VDC loop excitation supplies for each output channel. These power supplies can be selectively wired for sinking or sourcing allowing use with any combination of powered or unpowered milliamp I/O devices.

How to Order

Models are factory ranged. See I/O ranges above left. Ranges and options for each channel must be specified on order

Channel 1 input range

Channel 2 input range

Channel 1 output range

Channel 2 output range

Model	Description	Power
APD 2061	DuoPak 2 channel AC-DC, RTD.-DC converter/isolator/transmitter	85-265 VAC, 50/60 Hz or 60-300 VDC
APD 2061 D		9-30 VDC or 10-32 VAC

Sink or Source
 mA Output for
 Each Channel

Output LoopTracker
 LED for Each
 Channel

Adjustable Output
 Test Function for
 Each Channel

Zero and Span for
 Each Channel

Input LoopTracker
 LED for Each
 Channel

Custom I/O Ranges

Universal
 Power



Removable Plugs

See Wiring
 Diagrams on
 Next Page

LoopTracker

API exclusive features include four LoopTracker LEDs (green for each input, red for each output) that vary in intensity with changes in the process input and output signals.

These provide a quick visual picture of your process loop at all times and can greatly aid in saving time during initial startup and troubleshooting.

Output Test

An API exclusive feature includes output test buttons for each channel to provide a fixed output (independent of the input) when held depressed.

Terminals are also provided to operate the test functions remotely for each channel. This also allows use as a remote manual override to provide a temporary fixed output if desired.

The test output level for each channel is potentiometer adjustable from 0 to 100% of the output span. The output test greatly aids in saving time during initial startup and/or troubleshooting.

Options and Accessories

Options—add to end of model number

- R1 Channel 1 I/O reversal (i.e. 20-4 mA out)
- R2 Channel 2 I/O reversal (i.e. 20-4 mA out)
- R3 Channel 1 and channel 2 I/O reversal
- M19 Channel 1 high voltage output >10 V up to 20 V
- M29 Channel 2 high voltage output >10 V up to 20 V
- M39 Channel 1 and channel 2 high voltage output
- U Conformal coating for moisture resistance

Accessory—order as separate line item

API BP4 Spare removable 4 terminal plug, black

Precautions

WARNING! All wiring must be performed by a qualified electrician or instrumentation engineer. See diagram for terminal designations and wiring examples. Consult factory for assistance.

WARNING! Avoid shock hazards! Turn signal input, output, and power off before connecting or disconnecting wiring, or removing or installing module.

Précautions

ATTENTION! Tout le câblage doit être effectué par un électricien ou ingénieur en instrumentation qualifié. Voir le diagramme pour désignations des bornes et des exemples de câblage. Consulter l'usine pour assistance.

ATTENTION! Éviter les risques de choc! Fermez le signal d'entrée, le signal de sortie et l'alimentation électrique avant de connecter ou de déconnecter le câblage, ou de retirer ou d'installer le module.

API maintains a constant effort to upgrade and improve its products. Specifications are subject to change without notice. See api-usa.com for latest product information. Consult factory for your specific requirements.

 **WARNING:** This product can expose you to chemicals including nickel, which are known to the State of California to cause cancer or birth defects or other reproductive harm. For more information go to www.P65Warnings.ca.gov

Electrical Connections

Polarity must be observed for signal wiring connections. If the input and/or output do not function, check wiring and polarity. Each product is factory configured to your exact input and output ranges as indicated on the serial number label.

Outputs

For milliamp ranges determine if your devices provide power to the current loop or if the loop must be powered by the APD module. Typical voltage may be 9-24 VDC at your device's terminals if it provides power to the loop.

Device for Output Channel 1	Terminal	Terminal
Measuring/recording device accepts a voltage input.	3 (-)	4 (+)
Measuring/recording device has an unpowered or passive mA input. APD module provides the loop power.	3 (-)	4 (+20 V)
Measuring/recording device has a mA input and powers the current loop.	2 (-)	3 (+)
Device for Output Channel 2	Terminal	Terminal
Measuring/recording device accepts a voltage input.	7 (-)	8 (+)
Measuring/recording device has an unpowered or passive mA input. APD module provides the loop power.	7 (-)	8 (+20 V)
Measuring/recording device has a mA input and powers the current loop.	6 (-)	7 (+)

Input 1, AC

Any polarity may be used for an AC input. A transmitter DC power supply is available at terminals 22 and 23, but is not commonly used with an AC input.

AC Input Channel 1	Terminal	Terminal
Device with an AC voltage or AC milliamp output.	17	19
Transmitter power supply.	18 (+15 VDC)	19

Input 2, RTD Temperature

The sensor type and temperature range are factory configured. See the model/serial number label for sensor type and range.

Temperature Input Ch. 2	Term.	Term.	Term.
Two wire RTD	21 Signal -	Jumper 22 & 23	23 Signal +
Three wire RTD	21 Signal -	22 Exc.	23 Signal +

Module Power Terminals

Check label for module operating voltage to make sure it matches available power. The power supplies are fuse protected and the unit may be returned to API for fuse replacement.

When using DC power, either polarity is acceptable, but for consistency, wire positive (+) to terminal 25 and negative (-) to terminal 28.

Mounting to a DIN Rail

Install module vertically on a 35 mm DIN rail in a protective enclosure away from heat sources. Do not block air flow. Allow 1" (25 mm) above and below housing vents for air circulation.

1. Tilt front of module down and position the lower spring clips against the bottom edge of DIN rail.
2. Push front of module upward until upper mount snaps into place.

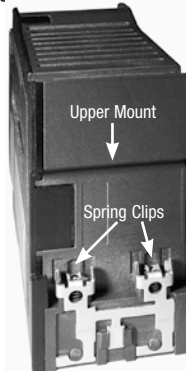

Removal

Avoid shock hazards! Turn signal input, output, and power off.

1. Push up on bottom back of module.
2. Tilt front of module downward to release upper mount from top edge of DIN rail.
3. The module can now be removed from the DIN rail.

Calibration

Front-mounted Zero and Span potentiometers for each channel can be used to compensate for load and lead variations.

1. Apply power to the module and allow a minimum 30 minute warm up time.
2. Using an accurate calibration source, provide an input to the module equal to the minimum input required for the application.
3. Using an accurate measurement device for the output, adjust the Zero potentiometer for the exact minimum output desired. The Zero control should only be adjusted when the input signal is at its minimum. This will produce the corresponding minimum output signal. For example: 4 mA for a 4-20 mA output or -10 V for a ±10 V output.
4. Set the input at maximum, and then adjust the Span pot for the exact maximum output desired. The Span control should only be adjusted when the input signal is at its maximum. This will produce the corresponding maximum output signal. Example: for 4-20 mA output, the Span control will provide adjustment for the 20 mA or high end of the signal.
5. Repeat adjustments for both output channels for maximum accuracy.

Output Test Function

When the Test button is depressed it will drive the output with a known good signal that can be used as a diagnostic aid during initial start-up or troubleshooting. When released, the output will return to normal.

Each Test Cal. potentiometer is factory set to approximately 50% output. Each can be adjusted to set the test output from 0 to 100% of the output span. Press and hold the Test button and adjust the corresponding Test Cal. potentiometer for the desired output level.

They may optionally be externally wired for remote test operation or a manual override. See wiring diagram at right.

Operation

The APD 2061 accepts one AC voltage or current input and one RTD input and provides two optically isolated DC voltage or current outputs that are linearly related to the inputs.

Green LoopTracker® input LEDs provide a visual indication that each signal is being sensed by the input circuitry of the module. They also indicates the input signal strength by changing in intensity as the process changes from minimum to maximum.

If an LED fails to illuminate, or fails to change in intensity as the process changes, check the module power or signal input wiring. Note that it may be difficult to see the LEDs under bright lighting conditions.

Two red LoopTracker output LEDs provide a visual indication that the output signals are functioning. They become brighter as the input and each corresponding output change from minimum to maximum.

For a current output the red LED will only light if the output loop current path is complete. For either current or voltage outputs, failure to illuminate or a failure to change in intensity as the process changes may indicate a problem with the module power or signal output wiring.

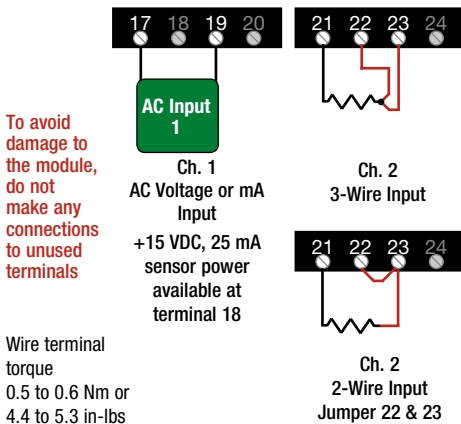
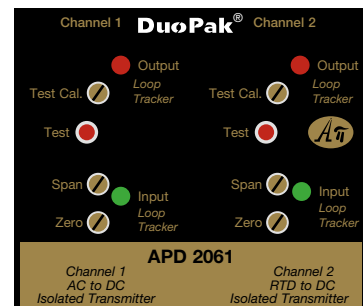
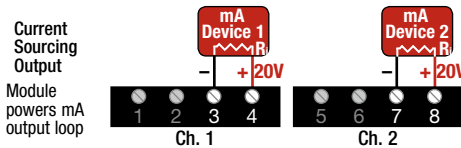
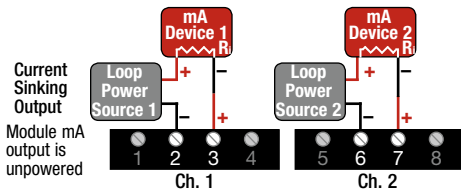
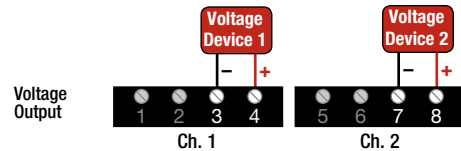

To avoid damage to the module, do not make any connections to unused terminals

Wire terminal torque
0.5 to 0.6 Nm or
4.4 to 5.3 in-lbs

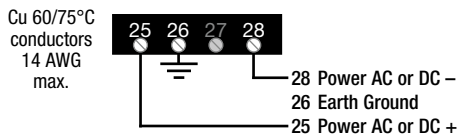

To maintain full isolation avoid combining power supplies in common with inputs, outputs, or unit power.