

Two Inputs: AC, DC, RTD, Frequency, Potentiometer, Strain
Two Output: 0-1 V to ±10 VDC, 0-1 mA to 0-20 mA, 4-20 mA

- Select Any Two I/O Types to Fit Your Application
- Removable Plugs for Easy Installation
- Full 2000 V Input/Output/Power Isolation
- Input and Output LoopTracker[®] LEDs
- Functional Test Button



Applications

- Simultaneous Voltage and Current Monitoring
- Monitor Current with Speed or Temperature
- Monitor DC Motor Shunts and Voltage

Inputs

Factory configured—specify input type and range for each channel. Standard DC mA inputs are sinking (unpowered). Inputs can be any two: DC V, DC mA, AC V, AC mA, RTD, frequency, potentiometer, or strain gauge. See table below.

LoopTracker LEDs

I/O LoopTracker LEDs for each channel
 Variable brightness green LED for input level and status
 Variable brightness red LED for output level and status

Outputs

Factory configured—specify output range for each channel
 Voltage: 0-1 VDC to 0-10 VDC, ±1 VDC to ±10 VDC
 Current: 0-1 mAADC to 0-20 mAADC sourcing (powered) std.
 1000 Ω at 20 mA, 20 V compliance

Consult factory for other ranges

Output Calibration

Multi-turn zero and span potentiometers for each channel
 ±15% of span adjustment range typical

Output Linearity, Ripple and Noise

Linearity better than ±0.1% of span
 Ripple and noise less than 10 mVRMS

Functional Test Button

One per channel
 Sets output to test level when pressed
 Factory set to approximately 50% of span

Common Mode Rejection

120 dB minimum

Isolation

2000 VRMS, 3-way: power/input, power/output, input/output

Ambient Temperature Range and Stability

-10°C to +60°C operating ambient
 Better than ±0.04% of span per °C stability

Power

DIN (standard) 80-265 VAC or 48-300 VDC, 6 W max.
 DD 9-30 VDC or 10-32 VAC, 6 W max.

Dimensions

2.17" W x 3.2" H x 4.33" D
 (55 x 81.3 x 110 mm)
 Height includes connectors

Free Factory I/O Setup!

Quick Link
api-usa.com/2000

2.17" W x 3.2" H x 4.33" D
 (55 x 81.3 x 110 mm)
 Height includes connectors



Removable Plugs

Description

The DuoPak converter/isolator provides two independent channels of signal conversion, isolation, and retransmission in one compact package. Each channel provides an isolated DC voltage or current output proportional to the input.

Full 3-way (input, output, power) isolation provides ground loop elimination, common mode signal rejection and signal noise reduction.

Order any combination of DC voltage, DC mA, AC voltage, AC mA, RTD, frequency, potentiometer, or strain gauge (load cell) inputs. The outputs can be any DC voltage or mA range indicated in the specifications. This flexibility allows you create a DuoPak for your exact application.

How to Order

DuoPak

API 20

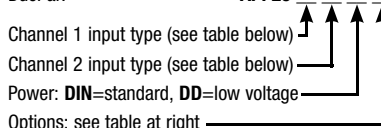

Specify input and output ranges for both channels!

Example: API 2071 DD EX1

Input 1: 0-5000 Hz Output 1: 4-20 mA sink

Input 2: 100Ω Pt 385, 0-200°C Output 2: 0-10 V

This DD example operates on 9-30 VDC or 10-32 VAC

Code	Input Type	Specify
0	DC	Range in mV, V, or mA
1	RTD	Ω, curve, temp. range, °F or °C
3	Potentiometer	Any full-range pot. is acceptable
5	Bridge	mV/V, excitation voltage
6	AC	Range in mV, V, or mA
7	Frequency	Range in Hz

LoopTracker LEDs

API's exclusive LoopTracker LEDs for each I/O channel vary in intensity with changes in the process input and output signals. Monitoring the state of these LEDs can provide a quick visual picture of your process loop at all times.

Output Test

API's exclusive functional test button can be used to verify the system operation for each channel by providing a fixed output (independent of the input) when held depressed.

The output test button greatly aids in saving time during initial startup and/or troubleshooting.

Specify an output range for each channel

Voltage: 0-1 VDC to 0-10 VDC
 Bipolar Voltage: ±1 VDC to ±10 VDC
 Current: 0-1 mAADC to 0-20 mAADC

Options—add to end of model number

Options	Description
L1	Ch.1 sourcing (powered) milliamp input
L2	Ch. 2 sourcing (powered) milliamp input
L3	Ch. 1 & 2 sourcing (powered) milliamp inputs
R1	Ch.1 I/O reversal, such as 20-4 mA output
R2	Ch. 2 I/O reversal, such as 20-4 mA output
R3	Ch. 1 & 2 I/O reversal, such as 20-4 mA outputs
EX1	Ch. 1 sinking (unpowered) mA output
EX2	Ch. 2 sinking (unpowered) mA output
EX3	Ch. 1 & ch. 2 sinking (unpowered) mA outputs
U	Moisture resistant conformal coating

Accessories—order as a separate line item

API GP8 Spare green 8 terminal connector
 API TK36 DIN rail, 35 mm W x 39" L, aluminum

DC Input	AC Input	RTD Input	Frequency Input	Potentiometer Input	Strain Gauge Input																		
Input Ranges 0-100 mVDC to 0-500 VDC 200 kΩ min. impedance ±100 mVDC to ±10 VDC 200 kΩ min. impedance 0-1 mAADC to 0-900 mAADC 1.25 VDC max. burden mA inputs sink current Response Time 70 milliseconds typical	Input Ranges 0-50 mVAC to 0-300 VAC 200 kΩ min. impedance 0-1 mAAC to 0-900 mAAC 1.0 VRMS max. burden Input Protection 750 VDC or 750 VAC, common mode Response Time 150 milliseconds typical	Input Ranges & Types Specify: 2- or 3-wire RTD, type, curve, °F or °C range Minimum span: 100°F or 55°C <table border="1"> <tr> <th>Resistance</th> <th>Type</th> </tr> <tr> <td>10 Ω</td> <td>Copper</td> </tr> <tr> <td>100 Ω</td> <td>Pt 0.00385</td> </tr> <tr> <td>100 Ω</td> <td>Pt 0.00392</td> </tr> <tr> <td>100 Ω</td> <td>Copper</td> </tr> <tr> <td>120 Ω</td> <td>Nickel</td> </tr> <tr> <td>1000 Ω</td> <td>Pt 0.00385</td> </tr> <tr> <td>1000 Ω</td> <td>Balco Ni-Fe</td> </tr> <tr> <td>2000 Ω</td> <td>Pt 0.00385</td> </tr> </table>	Resistance	Type	10 Ω	Copper	100 Ω	Pt 0.00385	100 Ω	Pt 0.00392	100 Ω	Copper	120 Ω	Nickel	1000 Ω	Pt 0.00385	1000 Ω	Balco Ni-Fe	2000 Ω	Pt 0.00385	Input Ranges 0-25 Hz to 0-20 kHz 100 kΩ minimum impedance Amplitude 100 mVRMS min., 150 VRMS max. Input Waveforms Sine, sawtooth, square wave, or others with greater than 100 mV amplitude change Sensor Power Supply 15 VDC regulated 25 mAADC	Input Ranges Minimum: 0-100 Ω Maximum: 0-1.0 MΩ Full travel of the potentiometer required Consult factory for other ranges Response Time 70 milliseconds typical	Input Ranges Specify: excitation voltage, sensor mV/V Minimum: 1 mV/V Maximum: 200 mV/V Excitation Voltage 10 VDC max. at 30 mA Response Time 70 milliseconds typical
Resistance	Type																						
10 Ω	Copper																						
100 Ω	Pt 0.00385																						
100 Ω	Pt 0.00392																						
100 Ω	Copper																						
120 Ω	Nickel																						
1000 Ω	Pt 0.00385																						
1000 Ω	Balco Ni-Fe																						
2000 Ω	Pt 0.00385																						

Models and Ranges

The serial number label identifies the input and output ranges for each channel, module power requirements, options, or if a custom range was specified.

The input and output ranges are factory set. The large product side label identifies the I/O types and the wiring connections. Use the wiring diagrams appropriate for your version.

Installation

The housing can be clipped to a standard 35 mm DIN rail (part number API TK36) or surface mounted.

Electrical Connections

WARNING! All wiring must be performed by a qualified electrician or instrumentation engineer. Refer to terminal designations and wiring examples or consult factory for assistance.

Avoid shock hazards! Turn power off to module power, signal input and output before connecting or disconnecting wiring.

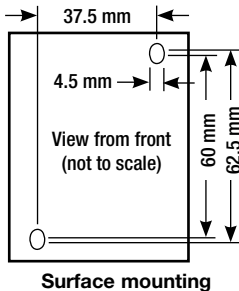

Surface mounting

DC Input Channel 1

Polarity must be observed when connecting a DC input signal. Refer to the sensor or transmitter manufacturer's data sheet for wiring requirements.

The standard DC milliamp input configuration sinks current. This requires connection to either a powered sensor or a passive sensor with a loop power supply in the circuit.

If the L1 or L3 option is specified, the DuoPak provides power to the milliamp input current loop. Only one device must provide power to the current loop.



DC ch. 1

AC Input Channel 1

Refer to the sensor or shunt manufacturer's data sheet for wiring requirements. Either polarity may be used for an AC input signal.



AC ch. 1

Frequency Input Channel 1

Refer to the sensor or transmitter manufacturer's data sheet for wiring requirements. The +15 VDC power may or may not be needed depending on the sensor type.



Frequency ch. 1

RTD Input Channel 1

Refer to the sensor manufacturer's data sheet for wiring requirements. For a 2-wire RTD connect a jumper from terminal 1 to terminal 3.

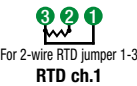

RTD ch. 1

Potentiometer Input Channel 1

Any potentiometer can be used as long as the full range is utilized.

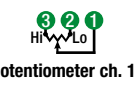

Potentiometer ch. 1

Bridge, Load Cell, Strain Gauge Input Channel 1

Connect for bridge sensor as shown at right. Refer to the manufacturer's data sheet for wiring requirements.



Strain Gauge ch. 1

Signal Output Channel 1

Polarity must be observed when connecting the signal output to the load.

For a milliamp output, the standard configuration sources current. This requires connection to a device with a passive input.

If the EX1 or EX3 option is specified, the milliamp output sinks current. This requires either a powered receiving device or a passive receiving device with a loop power supply in the circuit. Only one device must provide power to the current loop.



Output ch. 1

DC Input Channel 2

Polarity must be observed when connecting a DC input signal. Refer to the sensor or transmitter manufacturer's data sheet for wiring requirements.

The standard DC milliamp input configuration sinks current. This requires connection to either a powered sensor or a passive sensor with a loop power supply in the circuit.

If the L2 or L3 option is specified, the DuoPak provides power to the milliamp input current loop. Only one device must provide power to the current loop.

AC Input Channel 2

Refer to the sensor or shunt manufacturer's data sheet for wiring requirements. Either polarity may be used for an AC input signal.



AC ch. 2

Frequency Input Channel 2

Refer to the sensor or transmitter manufacturer's data sheet for wiring requirements. The +15 VDC power may or may not be needed depending on the sensor type.



Frequency ch. 2

RTD Input Channel 2

Refer to the sensor manufacturer's data sheet for wiring requirements. For a 2-wire RTD connect a jumper from terminal 9 to terminal 11.

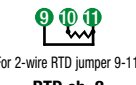

RTD ch. 2

Potentiometer Input Channel 2

Any potentiometer can be used as long as the full range is utilized.

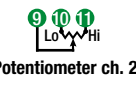

Potentiometer ch. 2

Bridge, Load Cell, Strain Gauge Input Channel 2

Connect for bridge sensor as shown at right. Refer to the manufacturer's data sheet for wiring requirements.

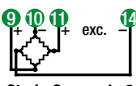

Strain Gauge ch. 2

Signal Output Channel 2

Polarity must be observed when connecting the signal output to the load.

For a milliamp output, the standard configuration sources current. This requires connection to a device with a passive input.

If the EX2 or EX3 option is specified, the milliamp output sinks current. This requires either a powered receiving device or a passive receiving device with a loop power supply in the circuit. Only one device must provide power to the current loop.



Output ch. 2

Module Power

The label on the side of the module will indicate the power requirements. Power wiring can be connected with either polarity. DD version polarity can be wired as shown for consistency.

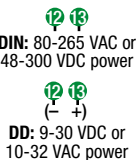

Calibration

The input ranges are factory calibrated and do not require adjustment. Zero and span calibration potentiometers are used to fine-tune the output of each channel if necessary.

1. Apply power to the module and allow a minimum 20 minute warm up time.
2. Provide an input to the module equal to zero or the minimum input required for the application.
3. Using an accurate measurement device for the module output, adjust the Zero potentiometer for the exact minimum output desired. The Zero control should only be adjusted when the input signal is at its minimum. This will produce the corresponding minimum output signal.
4. Set the input at maximum, and then adjust the Span potentiometer for the exact maximum output desired. The Span control should only be adjusted when the input signal is at its maximum. This will produce the corresponding maximum output signal.

tiometer for the exact maximum output desired. The Span control should only be adjusted when the input signal is at its maximum. This will produce the corresponding maximum output signal.

5. Repeat steps 1 through 4 for channel 2.

Output Test Function

The Test buttons are factory set to provide approximately 50% full scale output when depressed. They will drive the device on the output side of the loop (panel meter, chart recorder, etc.) with a known good signal that can be used as a diagnostic aid during initial start-up or during troubleshooting. When released, the output will return to normal.

Operation

Each green LoopTracker® input LED provides a visual indication that a signal is being sensed by the input circuitry of the module. It also indicates the input signal level by changing in intensity as the process changes from minimum to maximum.

Each red LoopTracker output LED provides a visual indication that the output signal is functioning. It becomes brighter as the input and the corresponding output change from minimum to maximum.

If an LED fails to illuminate, or fails to change in intensity as the process changes, this may indicate a problem with module power or signal input or output wiring. For current outputs, the red LED will only light if the output loop current path is complete. Note that it may be difficult to see the LEDs under bright lighting conditions.

DuoPak Wiring and Ordering Example

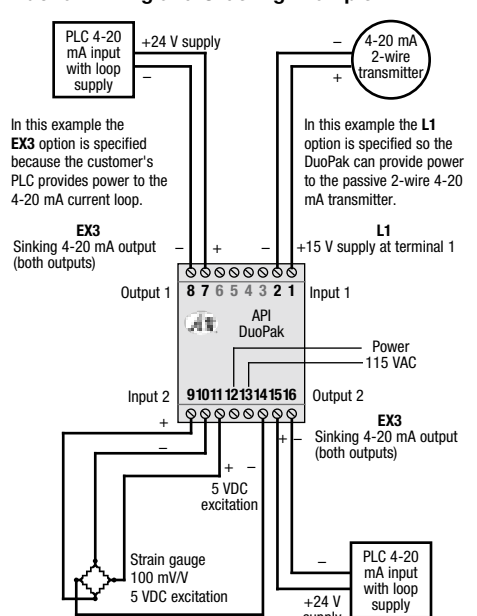

A PLC receives two 4-20 mA signals from two sensors. Both PLC inputs provide power to the current loop, so the DuoPak must be ordered with EX3 passive outputs on both channels.

The DuoPak provides signal isolation for the channel one 4-20 mA signal. The L1 option provides 15 VDC to power the passive 2-wire transmitter.

The DuoPak provides signal isolation and conversion for the strain gauge connected to channel 2. The DuoPak also provides excitation voltage to the strain gauge.

The unit operates on 80-265 VAC or 48-300 VDC.

To order this example the following must be specified:

- API 2005 DIN L1 EX3**
Input 1: 4-20 mA
Output 1: 4-20 mA
Input 2: Strain Gauge, 100mV/V, 5 V Excitation
Output 2: 4-20 mA

API maintains a constant effort to upgrade and improve its products. Specifications are subject to change without notice. Consult factory for your specific requirements.